

User Manual

11KW TWIN SOLAR INVERTER / CHARGER



Table of Contents

ABOUT THIS MANUAL	2
Purpose.....	2
Scope.....	2
SAFETY INSTRUCTIONS.....	2
INTRODUCTION	3
Features.....	3
Basic System Architecture	3
Product Overview.....	4
Unpacking and Inspection	5
Preparation	5
Mounting the Unit.....	5
Battery Connection	6
AC Input/Output Connection.....	7
PV Connection	9
Final Assembly.....	11
Remote Display Panel Installation	11
Communication Connection.....	13
Dry Contact Signal.....	14
BMS Communication	14
OPERATION.....	15
Power ON/OFF	15
Inverter Turn-on	15
Operation and Display Panel	15
LCD Display Icons	16
LCD Setting.....	18
LCD Display	31
Operating Mode Description	37
Faults Reference Code	39
Warning Indicator.....	40
BATTERY EQUALIZATION	41
SPECIFICATIONS.....	42
Table 1 Line Mode Specifications	42
Table 2 Inverter Mode Specifications	43
Table 3 Charge Mode Specifications.....	44
Table 4 General Specifications.....	45
TROUBLE SHOOTING	46
Appendix I: Parallel function	47
Appendix II: BMS Communication Installation.....	59
Appendix III: The Wi-Fi Operation Guide in Remote Panel	65

ABOUT THIS MANUAL

Purpose

This manual describes the assembly, installation, operation and troubleshooting of this unit. Please read this manual carefully before installations and operations. Keep this manual for future reference.

Scope

This manual provides safety and installation guidelines as well as information on tools and wiring.

SAFETY INSTRUCTIONS

⚠ WARNING: This chapter contains important safety and operating instructions. Read and keep this manual for future reference.

1. Before using the unit, read all instructions and cautionary markings on the unit, the batteries and all appropriate sections of this manual.
2. **CAUTION** --To reduce risk of injury, charge only deep-cycle lead acid type rechargeable batteries. Other types of batteries may burst, causing personal injury and damage.
3. Do not disassemble the unit. Take it to a qualified service center when service or repair is required. Incorrect re-assembly may result in a risk of electric shock or fire.
4. To reduce risk of electric shock, disconnect all wirings before attempting any maintenance or cleaning. Turning off the unit will not reduce this risk.
5. **CAUTION** – Only qualified personnel can install this device with battery.
6. **NEVER** charge a frozen battery.
7. For optimum operation of this inverter/charger, please follow required spec to select appropriate cable size. It's very important to correctly operate this inverter/charger.
8. Be very cautious when working with metal tools on or around batteries. A potential risk exists to drop a tool to spark or short circuit batteries or other electrical parts and could cause an explosion.
9. Please strictly follow installation procedure when you want to disconnect AC or DC terminals. Please refer to INSTALLATION section of this manual for the details.
10. Fuses are provided as over-current protection for the battery supply.
11. **GROUNDING INSTRUCTIONS** -This inverter/charger should be connected to a permanent grounded wiring system. Be sure to comply with local requirements and regulation to install this inverter.
12. **NEVER** cause AC output and DC input short circuited. Do NOT connect to the mains when DC input short circuits.
13. **Warning!!** Only qualified service persons are able to service this device. If errors still persist after following troubleshooting table, please send this inverter/charger back to local dealer or service center for maintenance.
14. **WARNING:** Because this inverter is non-isolated, only three types of PV modules are acceptable: single crystalline, poly crystalline with class A-rated and CIGS modules. To avoid any malfunction, do not connect any PV modules with possible current leakage to the inverter. For example, grounded PV modules will cause current leakage to the inverter. When using CIGS modules, please be sure NO grounding.
15. **CAUTION:** It's required to use PV junction box with surge protection. Otherwise, it will cause damage on inverter when lightning occurs on PV modules.

INTRODUCTION

This is a multi-function inverter, combining functions of inverter, solar charger and battery charger to offer uninterruptible power support in a single package. The comprehensive LCD display offers user-configurable and easy-accessible button operations such as battery charging current, AC or solar charging priority, and acceptable input voltage based on different applications.

Features

- Pure sine wave inverter
- Configurable color with the built-in RGB LED bar
- Built-in Wi-Fi for mobile monitoring (APP is required)
- Supports USB On-the-Go function
- Built-in anti-dusk kit
- Detachable LCD control module with multiple communication ports for BMS (RS485, CAN-BUS, RS232)
- Configurable input voltage ranges for home appliances and personal computers via LCD control panel
- Configurable AC/PV output usage timer and prioritization
- Configurable AC/Solar charger priority via LCD control panel
- Configurable battery charging current based on applications via LCD control panel
- Compatible to utility mains or generator power
- Auto restart while AC is recovering
- Overload / Over temperature / short circuit protection
- Smart battery charger design for optimized battery performance
- Cold start function

Basic System Architecture

The following illustration shows basic application for this unit. It also required the following devices to have a complete running system:

- Generator or Utility mains.
- PV modules

Consult with your system integrator for other possible system architectures depending on your requirements.

This inverter can power various appliances in home or office environment, including motor-type appliances such as tube light, fan, refrigerator and air conditioners.

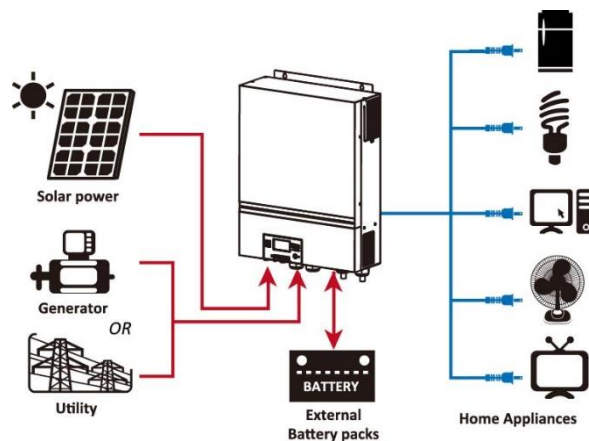
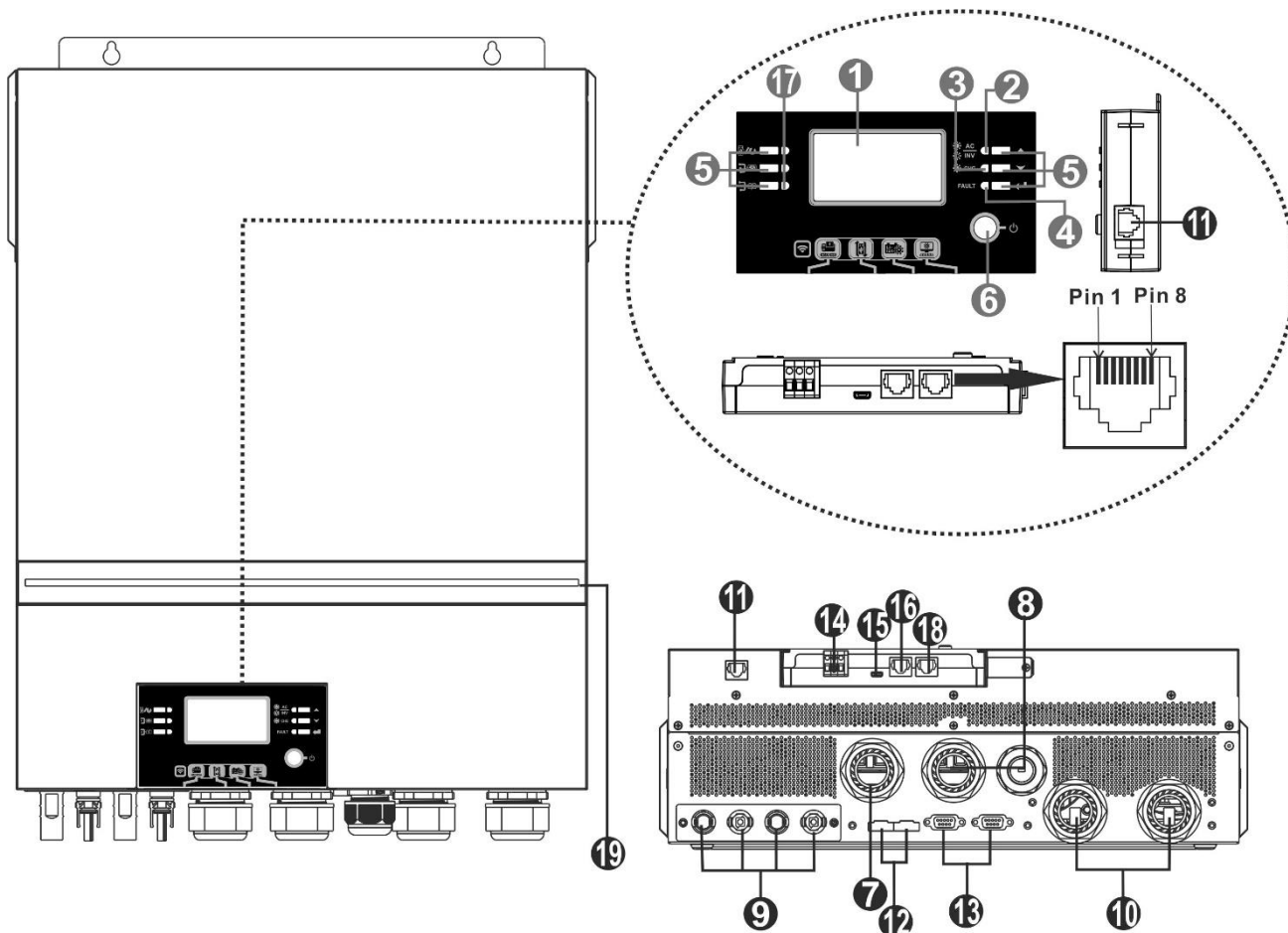

Figure 1 Basic hybrid PV System Overview

Product Overview



NOTE: For parallel installation and operation, please check *Appendix I*.

- | | |
|---|---|
| 1. LCD display | 12. Current sharing port |
| 2. Status indicator | 13. Parallel communication port |
| 3. Charging indicator | 14. Dry contact |
| 4. Fault indicator | 15. USB port as USB communication port and USB function port |
| 5. Function buttons | 16. BMS communication port: CAN, RS-485 or RS-232 |
| 6. Power on/off switch | 17. Output source indicators (refer to OPERATION/Operation and Display Panel section for details) and USB function setting reminder (refer to OPERATION/Function Setting for the details) |
| 7. AC input connectors | 18. RS-232 communication port |
| 8. AC output connectors (Load connection) | 19. RGB LED bar (refer to LCD Setting section for the details) |
| 9. PV connectors | |
| 10. Battery connectors | |
| 11. Remote LCD module communication Port | |

INSTALLATION

Unpacking and Inspection

Before installation, please inspect the unit. Be sure that nothing inside the package is damaged. You should have received the following items inside of package:

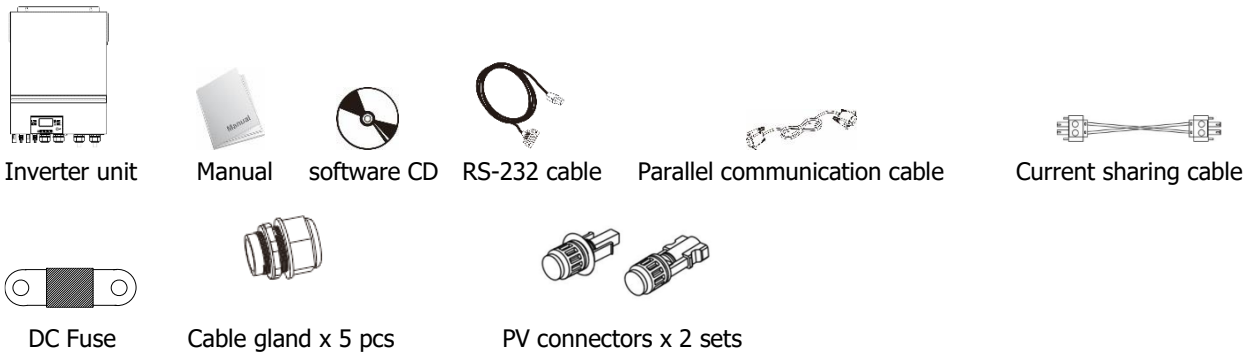

Preparation

Before connecting all wirings, please take off bottom cover by removing five screws. When removing the bottom cover, be carefully to remove three cables as shown below.

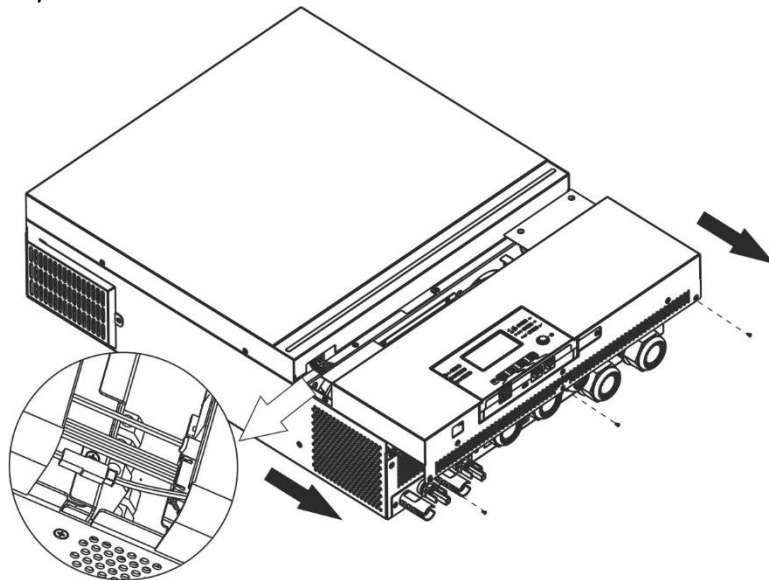

Mounting the Unit

Consider the following points before selecting where to install:

- Do not mount the inverter on flammable construction materials.
- Mount on a solid surface
- Install this inverter at eye level in order to allow the LCD display to be read at all times.
- The ambient temperature should be between 0°C and 55°C to ensure optimal operation.
- The recommended installation position is to be adhered to the wall vertically.
- Be sure to keep other objects and surfaces as shown in the right diagram to guarantee sufficient heat dissipation and to have enough space for removing wires.

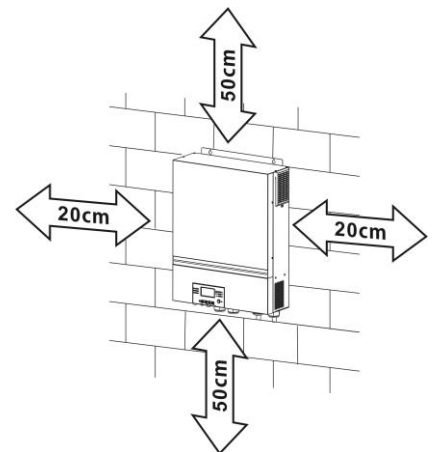

⚠ SUITABLE FOR MOUNTING ON CONCRETE OR OTHER NON-COMBUSTIBLE SURFACE ONLY.

Install the unit by screwing four screws. It's recommended to use M4 or M5 screws.

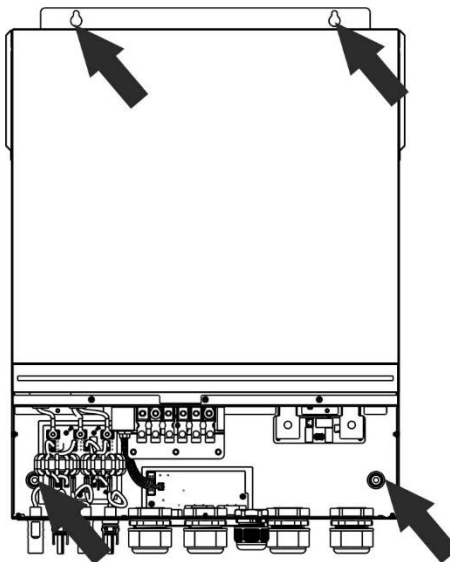

Battery Connection

CAUTION: For safety operation and regulation compliance, it's requested to install a separate DC over-current protector or disconnect device between battery and inverter. It may not be requested to have a disconnect device in some applications, however, it's still requested to have over-current protection installed. Please refer to typical amperage in below table as required fuse or breaker size.

WARNING! All wiring must be performed by a qualified personnel.

WARNING! It's very important for system safety and efficient operation to use appropriate cable for battery connection. To reduce risk of injury, please use the proper recommended cable and terminal size as below.

Ring terminal:

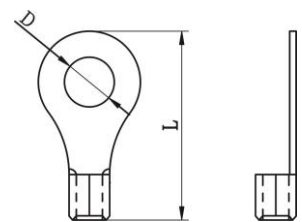



Recommended battery cable and terminal size:

Model	Typical Amperage	Battery capacity	Wire Size	Cable mm ²	Ring Terminal Dimensions		Torque value
					D (mm)	L (mm)	
11KW	228A	250AH	1*3/0AWG	85	8.4	54	5 Nm

Please follow below steps to implement battery connection:

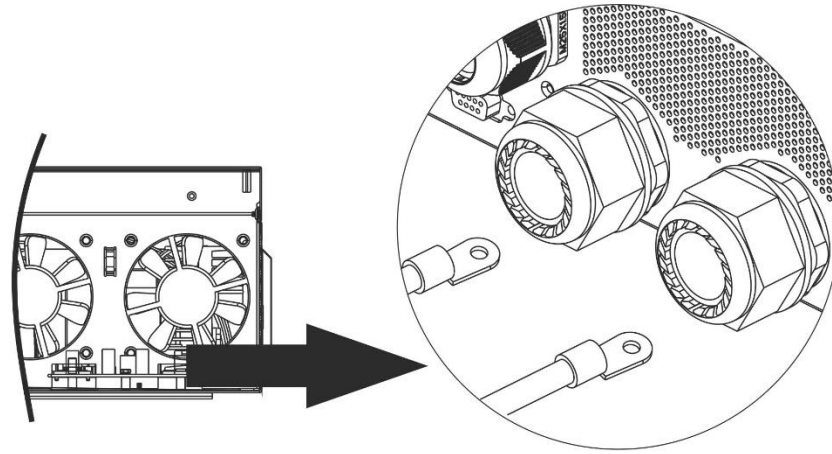
1. Assemble battery ring terminal based on recommended battery cable and terminal size.
2. Fix two cable glands into positive and negative terminals.
3. Insert the ring terminal of battery cable flatly into battery connector of inverter and make sure the nuts are tightened with torque of 5 Nm. Make sure polarity at both the battery and the inverter/charge is correctly connected and ring terminals are tightly screwed to the battery terminals.



 **WARNING: Shock Hazard**
Installation must be performed with care due to high battery voltage in series.

 **CAUTION!!** Do not place anything between the flat part of the inverter terminal and the ring terminal. Otherwise, overheating may occur.
CAUTION!! Do not apply anti-oxidant substance on the terminals before terminals are connected tightly.
CAUTION!! Before making the final DC connection or closing DC breaker/disconnector, be sure positive (+) must be connected to positive (+) and negative (-) must be connected to negative (-).

AC Input/Output Connection

CAUTION!! Before connecting to AC input power source, please install a **separate** AC breaker between inverter and AC input power source. This will ensure the inverter can be securely disconnected during maintenance and fully protected from over current of AC input.

CAUTION!! There are two terminal blocks with "IN" and "OUT" markings. Please do NOT mis-connect input and output connectors.

WARNING! All wiring must be performed by a qualified personnel.

WARNING! It's very important for system safety and efficient operation to use appropriate cable for AC input connection. To reduce risk of injury, please use the proper recommended cable size as below.

Suggested cable requirement for AC wires

Model	Gauge	Torque Value
11KW	8 AWG	1.4~ 1.6Nm

Please follow below steps to implement AC input/output connection:

1. Before making AC input/output connection, be sure to open DC protector or disconnecter first.
2. Remove insulation sleeve 10mm for six conductors. And shorten phase L and neutral conductor N 3 mm.
3. Fix two cable glands into input and output sides.
4. Insert AC input wires according to polarities indicated on terminal block and tighten the terminal screws.

Be sure to connect PE protective conductor (⊕) first.

⊕ → **Ground (yellow-green)**

L → **LINE (brown or black)**

N → **Neutral (blue)**

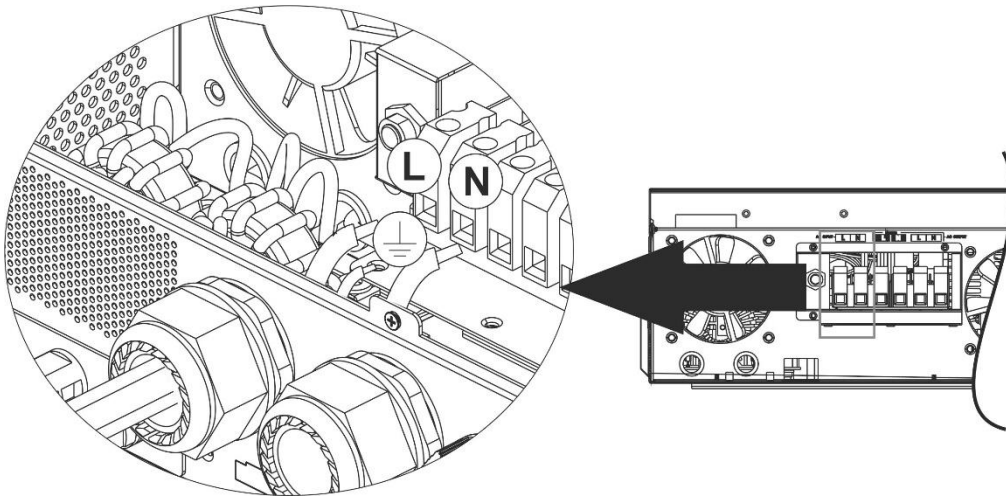

 **WARNING:** Be sure that AC power source is disconnected before attempting to hardwire it to the unit.

5. This inverter is equipped with dual-output. There are four terminals (L1/N1, L2/N2) available on output port. It's set up through LCD program or monitoring software to turn on and off the second output. Refer to "LCD setting" section for the details. Insert AC output wires according to polarities indicated on terminal block and tighten terminal screws. Be sure to connect PE protective conductor (⊕) first.

- ⊕ → **Ground (yellow-green)**
- L1 → **LINE (brown or black)**
- N1 → **Neutral (blue)**
- L2 → **LINE (brown or black)**
- N2 → **Neutral (blue)**

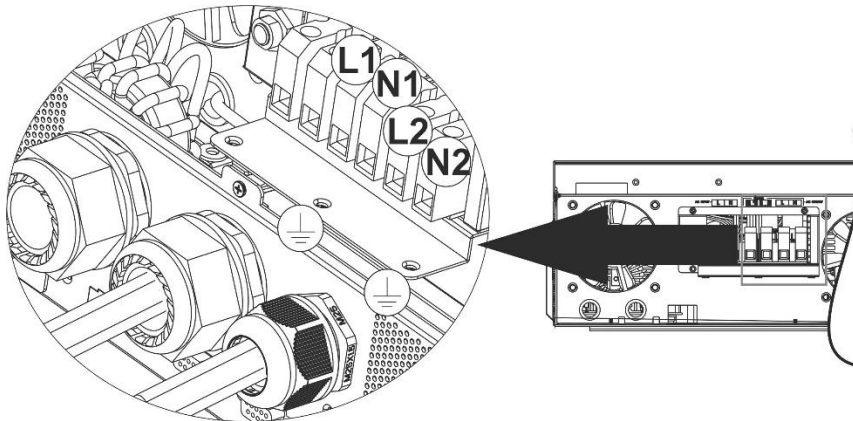

6. Make sure the wires are securely connected.

CAUTION: Important

Be sure to connect AC wires with correct polarity. If L and N wires are connected reversely, it may cause utility short-circuited when these inverters are worked in parallel operation.

CAUTION: Appliances such as air conditioner requires at least 2~3 minutes to restart because it's required to have enough time to balance refrigerant gas inside of circuits. If a power shortage occurs and recovers in a short time, it will cause damage to your connected appliances. To prevent this kind of damage, please check manufacturer of air conditioner if it's equipped with time-delay function before installation. Otherwise, this inverter/charger will be trigger overload fault and cut off output to protect your appliance but sometimes it still causes internal damage to the air conditioner.

PV Connection

CAUTION: Before connecting to PV modules, please install **separately** DC circuit breakers between inverter and PV modules.

NOTE1: Please use 600VDC/30A circuit breaker.

NOTE2: The overvoltage category of the PV input is II.

Please follow the steps below to implement PV module connection:

WARNING: Because this inverter is non-isolated, only three types of PV modules are acceptable: single crystalline and poly crystalline with class A-rated and CIGS modules.
 To avoid any malfunction, do not connect any PV modules with possible current leakage to the inverter. For example, grounded PV modules will cause current leakage to the inverter. When using CIGS modules, please be sure NO grounding.
CAUTION: It's required to use PV junction box with surge protection. Otherwise, it will cause damage on inverter when lightning occurs on PV modules.





Step 1: Check the input voltage of PV array modules. This system is applied with two strings of PV array. Please make sure that the maximum current load of each PV input connector is 18A.

CAUTION: Exceeding the maximum input voltage can destroy the unit!! Check the system before wire connection.

Step 2: Disconnect the circuit breaker and switch off the DC switch.

Step 3: Assemble provided PV connectors with PV modules by the following steps.

Components for PV connectors and Tools:

Female connector housing	
Female terminal	
Male connector housing	
Male terminal	
Crimping tool and spanner	

Prepare the cable and follow the connector assembly process:

Strip one cable 8 mm on both end sides and be careful NOT to nick conductors.

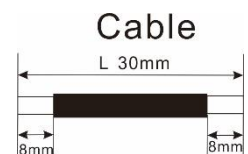

Insert striped cable into female terminal and crimp female terminal as shown below.



Insert assembled cable into female connector housing as shown below.



Insert striped cable into male terminal and crimp male terminal as shown below.



Insert assembled cable into male connector housing as shown below.



Then, use spanner to screw pressure dome tightly to female connector and male connector as shown below.



Step 4: Check correct polarity of connection cable from PV modules and PV input connectors. Then, connect positive pole (+) of connection cable to positive pole (+) of PV input connector. Connect negative pole (-) of connection cable to negative pole (-) of PV input connector.

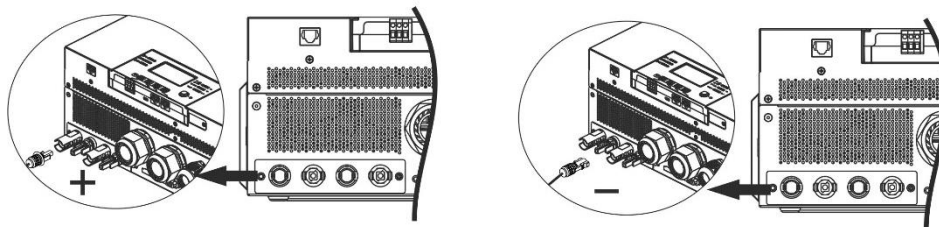

WARNING! For safety and efficiency, it's very important to use appropriate cables for PV module connection. To reduce risk of injury, please use the proper cable size as recommended below.

Conductor cross-section (mm ²)	AWG no.
4~6	10~12

CAUTION: Never directly touch the terminals of inverter. It might cause lethal electric shock.

Recommended Panel Configuration

When selecting proper PV modules, please be sure to consider the following parameters:

1. Open circuit Voltage (Voc) of PV modules not to exceed maximum PV array open circuit voltage of the inverter.
2. Open circuit Voltage (Voc) of PV modules should be higher than the start-up voltage.

INVERTER MODEL	11KW
Max. PV Array Power	11000W
Max. PV Array Open Circuit Voltage	500Vdc
PV Array MPPT Voltage Range	90Vdc~450Vdc
Start-up Voltage (Voc)	80Vdc

Recommended solar panel configuration:

Solar Panel Spec. (reference)	SOLAR INPUT 1	SOLAR INPUT 2	Q'ty of panels	Total Input Power
	Min in series: 4pcs, per input Max. in series: 12pcs, per input			
- 250Wp	4pcs in series	x	4pcs	1000W
- Vmp: 30.7Vdc	x	4pcs in series	4pcs	1000W
- Imp: 8.3A	12pcs in series	x	12pcs	3000W
- Voc: 37.7Vdc	x	12pcs in series	12pcs	3000W
- Isc: 8.4A	6pcs in series	6pcs in series	12pcs	3000W
- Cells: 60	6pcs in series, 2 strings	x	12pcs	3000W
	x	6pcs in series, 2 strings	12pcs	3000W
	8pcs in series, 2 strings	x	16pcs	4000W
	x	8pcs in series, 2 strings	16pcs	4000W
	11pcs in series, 2 strings	x	22pcs	5500W
	x	11pcs in series, 2 strings	22pcs	5500W
	9pcs in series, 1 string	9pcs in series, 1 string	18pcs	4500W
	10pcs in series, 1 string	10pcs in series, 1 string	20pcs	5000W
	12pcs in series, 1 string	12pcs in series, 1 string	24pcs	6000W

	6pcs in series, 2 strings	6pcs in series, 2 strings	24pcs	6000W
	7pcs in series, 2 strings	7pcs in series, 2 strings	28pcs	7000W
	8pcs in series, 2 strings	8pcs in series, 2 strings	32pcs	8000W
	9pcs in series, 2 strings	9pcs in series, 2 strings	36pcs	9000W
	10pcs in series, 2 strings	10pcs in series, 2 strings	40pcs	10000W
	11pcs in series, 2 strings	11pcs in series, 2 strings	44pcs	11000W

Take the 555Wp PV module as an example. After considering above two parameters, the recommended module configurations are listed in the table below.

Solar Panel Spec. (reference) - 555Wp - Imp: 17.32A - Voc: 38.46Vdc - Isc: 18.33A - Cells: 110	SOLAR INPUT 1	SOLAR INPUT 2	Q'ty of panels	Total Input Power
	Min in series: 3pcs, per input			
Max. in series: 10pcs, per input				
	3pcs in series	x	3pcs	1665W
	x	3pcs in series	3pcs	1665W
	7pcs in series	x	7pcs	3885W
	x	7pcs in series	7pcs	3885W
	10pcs in series	x	10pcs	5550W
	x	10pcs in series	10pcs	5550W
	7pcs in series	7pcs in series	14pcs	7770W
	10pcs in series	10pcs in series	20pcs	11100W

Final Assembly

After connecting all wirings, re-connect three cables and then put bottom cover back by screwing five screws as shown below.

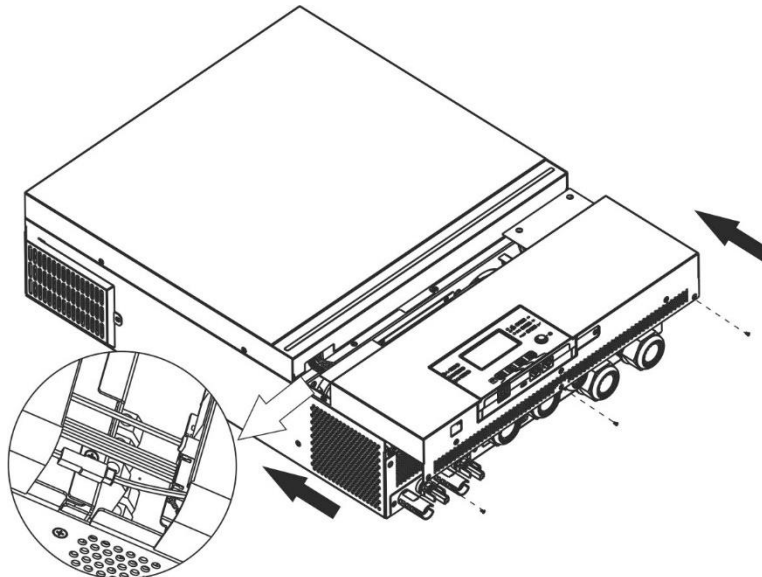

Remote Display Panel Installation

The LCD module can be removable and installed in a remote location with an optional communication cable. Please take the follow steps to implement this remote panel installation.

Step 1. Remove the screw on the bottom of LCD module and pull down the module from the case. Detach the cable from the original communication port. Be sure to replace the retention plate back to the inverter.

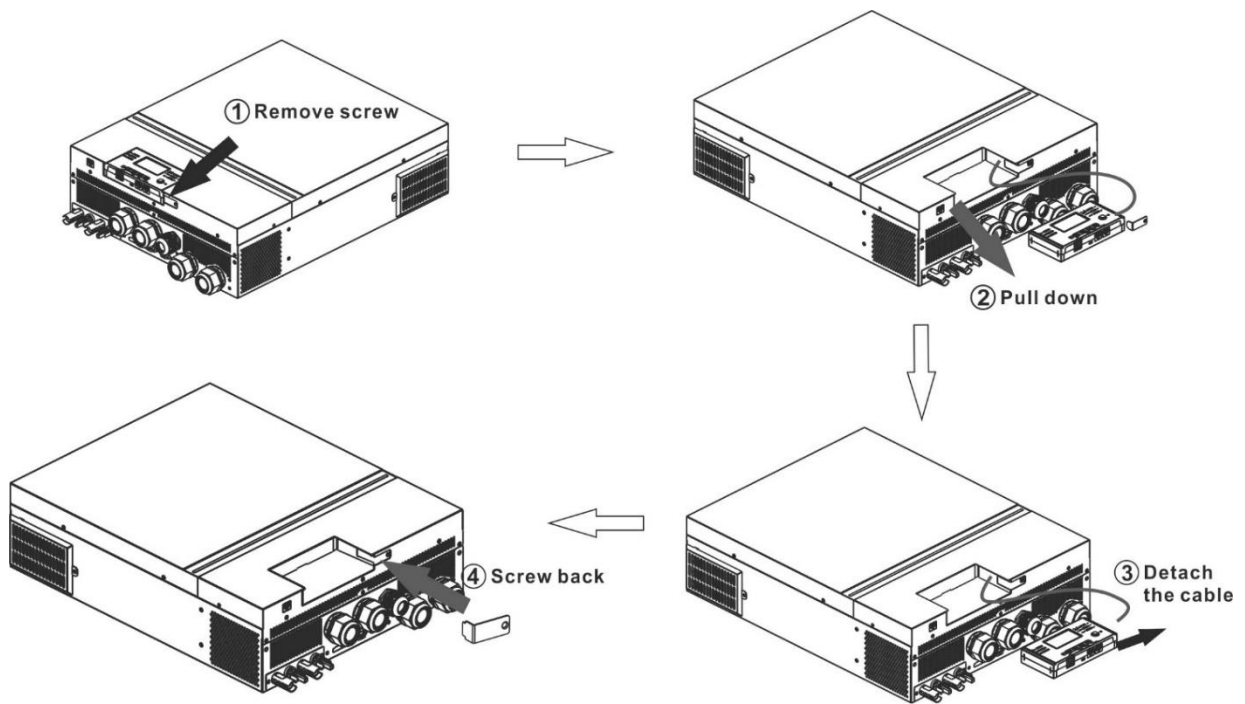

Step 2. Prepare your mounting holes in the marked locations as shown in the illustration below. The LCD module then can be securely mounted to your desired location.

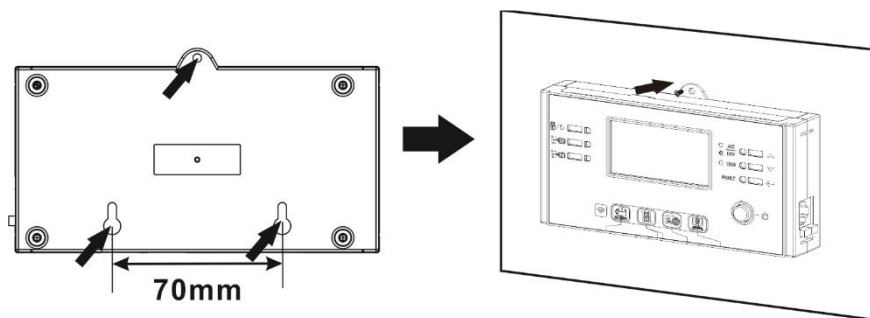

Note: Wall installation should be implemented with the proper screws to the right.



Step 3. After LCD module is installed, connect LCD module to the inverter with an optional RJ45 communication cable as shown below.

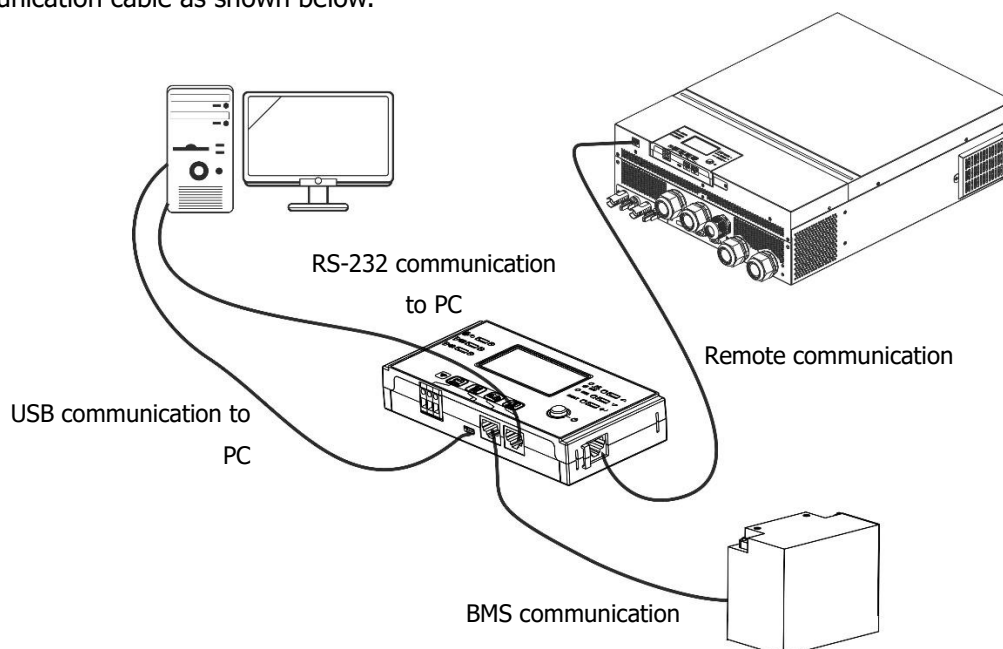

Communication Connection

Serial Connection

Please use the supplied serial cable to connect between the inverter and your PC. Install the monitoring software from the bundled CD and follow the on-screen instructions to complete your installation. For detailed software operation, refer to the software user manual on the bundled CD.

Wi-Fi Connection

This unit is equipped with a Wi-Fi transmitter. Wi-Fi transmitter can enable wireless communication between off-grid inverters and monitoring platform. Users can access and control the monitored inverter with downloaded APP. You may find "WatchPower" app from the Apple® Store or "WatchPower Wi-Fi" in Google® Play Store. All data loggers and parameters are saved in iCloud. For quick installation and operation, please check Appendix III.



Dry Contact Signal

There is one dry contact (3A/250VAC) available on the rear panel. It could be used to deliver signal to external device when battery voltage reaches warning level.

Unit Status	Condition			 Dry contact port: NC C NO	
				NC & C	NO & C
Power Off	Unit is off and no output is powered.			Close	Open
Power On	Output is powered from Battery power or Solar energy.	Program 01 set as USB (utility first) or SUB (solar first)	Battery voltage < Low DC warning voltage	Open	Close
			Battery voltage > Setting value in Program 13 or battery charging reaches floating stage	Close	Open
		Program 01 is set as SBU (SBU priority)	Battery voltage < Setting value in Program 12	Open	Close
			Battery voltage > Setting value in Program 13 or battery charging reaches floating stage	Close	Open

BMS Communication

It is recommended to purchase a special communication cable if you are connecting to Lithium-Ion battery banks. Please refer to *Appendix II- BMS Communication Installation* for details.

OPERATION

Power ON/OFF

Once the unit has been properly installed and the batteries are connected well, simply press On/Off switch (located on the display panel) to turn on the unit.

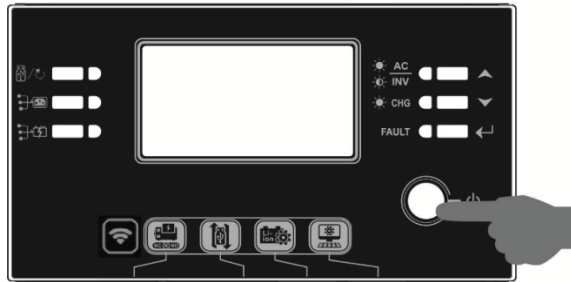

Inverter Turn-on

After this inverter is turned on, WELCOME light show will be started with RGB LED BAR. It will slowly cycle through entire spectrum of nine colors (Green, Sky blue, Royal blue, Violet, Pink, Red, Honey, Yellow, Lime yellow) about 10-15 seconds. After initialization, it will light up with default color.

RGB LED BAR can light up in different color and light effects based on the setting of energy priority to display the operation mode, energy source, battery capacity and load level. These parameters such as color, effects, brightness, speed and so on can be configured through the LCD panel. Please refer to LCD settings for the details.

Operation and Display Panel



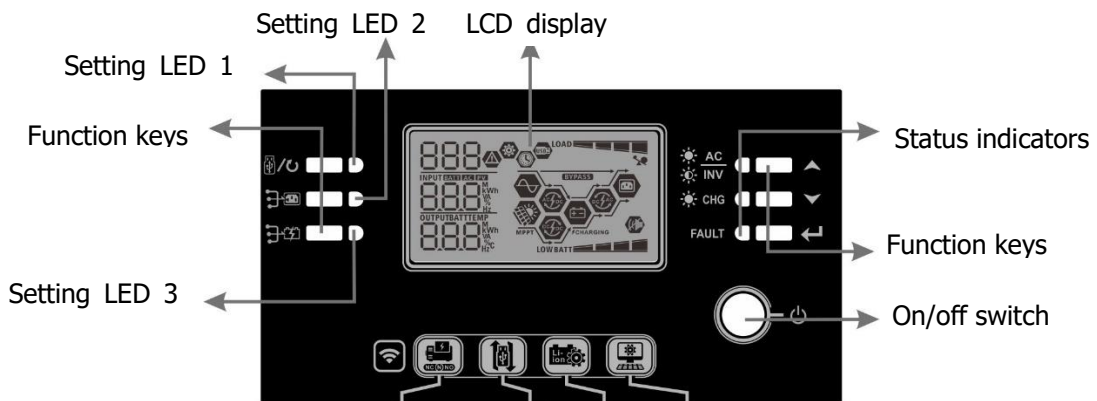



The operation and the LCD module, shown in the chart below, includes six indicators, six function keys, on/off switch and a LCD display to indicate the operating status and input/output power information.



Indicators

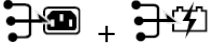





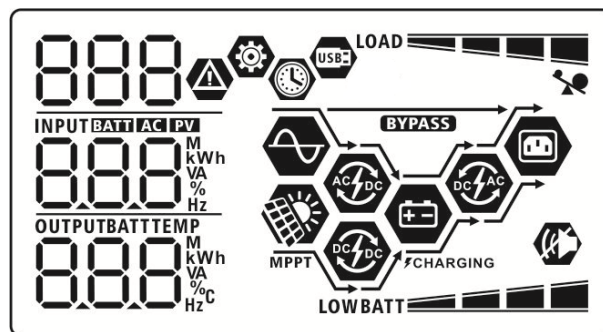

LED Indicator	Color	Solid/Flashing	Messages
Setting LED 1	Green	Solid On	Output powered by utility
Setting LED 2	Green	Solid On	Output powered by PV
Setting LED 3	Green	Solid On	Output powered by battery
Status indicators		Green Solid On	Output is available in line mode
		Green Flashing	Output is powered by battery in battery mode
		Green Solid On	Battery is fully charged
		Green Flashing	Battery is charging.
	FAULT	Red Solid On	Fault mode
		Red Flashing	Warning mode

























Function Keys

Function Key	Description	
	ESC	Exit the setting
	USB function setting	Select USB OTG functions
	Timer setting for the Output source priority	Setup the timer for prioritizing the output source
	Timer setting for the Charger source priority	Setup the timer for prioritizing the charger source
		Press these two keys at the time to switch RGB LED bar for output source priority and battery discharge/charge status
	Up	To last selection
	Down	To next selection
	Enter	To confirm/enter the selection in setting mode

LCD Display Icons



Icon	Function description
Input Source Information	
	Indicates the AC input.
	Indicates the PV input
	Indicate input voltage, input frequency, PV voltage, charger current, charger power, battery voltage.
Configuration Program and Fault Information	
	Indicates the setting programs.
	Indicates the warning and fault codes. Warning:  flashing with warning code. Fault:  lighting with fault code
Output Information	
	Indicate output voltage, output frequency, load percent, load in VA, load in Watt and discharging current.
OUTPUT	The ICON flashing that indicate the unit with AC output and setting Programs 60, 61 or 62 different to default setting.
Battery Information	





BATT 	Indicates battery level by 0-24%, 25-49%, 50-74% and 75-100% in battery mode and charging status in line mode.	
When battery is charging, it will present battery charging status.		
Status	Battery voltage	LCD Display
Constant Current mode / Constant Voltage mode	<2V/cell	4 bars will flash in turns.
	2 ~ 2.083V/cell	Bottom bar will be on and the other three bars will flash in turns.
	2.083 ~ 2.167V/cell	Bottom two bars will be on and the other two bars will flash in turns.
	> 2.167 V/cell	Bottom three bars will be on and the top bar will flash.
Floating mode. Batteries are fully charged.		4 bars will be on.
In battery mode, it will present battery capacity.		
Load Percentage	Battery Voltage	LCD Display
Load >50%	< 1.85V/cell	LOWBATT 
	1.85V/cell ~ 1.933V/cell	BATT 
	1.933V/cell ~ 2.017V/cell	BATT 
	> 2.017V/cell	BATT 
Load < 50%	< 1.892V/cell	LOWBATT 
	1.892V/cell ~ 1.975V/cell	BATT 
	1.975V/cell ~ 2.058V/cell	BATT 
	> 2.058V/cell	BATT 
Load Information		
	Indicates overload.	
LOAD  	Indicates the load level by 0-24%, 25-49%, 50-74% and 75-100%.	
	0%~24%	25%~49%
	LOAD 	LOAD 
	50%~74%	75%~100%
LOAD 	LOAD 	
Mode Operation Information		
	Indicates unit connects to the mains.	
 MPPT	Indicates unit connects to the PV panel.	
BYPASS	Indicates load is supplied by utility power.	
	Indicates the utility charger circuit is working.	
	Indicates the solar charger circuit is working.	
	Indicates the DC/AC inverter circuit is working.	
	Indicates unit alarm is disabled.	
	Indicates USB disk is connected.	
	Indicates timer setting or time display	









LCD Setting













General Setting









After pressing and holding "←" button for 3 seconds, the unit will enter the Setup Mode. Press "▲" or "▼" button to select setting programs. Press "←" button to confirm you selection or "⏏/↺" button to exit.











Setting Programs:









Program	Description	Selectable option	
00	Exit setting mode	Escape 00  ESC	
01	Output source priority: To configure load power source priority	Utility first (default) 01  USb	Utility will provide power to the loads as first priority. Solar and battery energy will provide power to the loads only when utility power is not available.
		Solar first 01  Sub	Solar energy provides power to the loads as first priority. If solar energy is not sufficient to power all connected loads, Utility energy will supply power to the loads at the same time.
		SBU priority 01  SbU	Solar energy provides power to the loads as first priority. If solar energy is not sufficient to power all connected loads, battery energy will supply power to the loads at the same time. Utility provides power to the loads only when battery voltage drops to either low-level warning voltage or the setting point in program 12.
02	Maximum charging current: To configure total charging current for solar and utility chargers. (Max. charging current = utility charging current + solar charging current)	60A (default) 02  60 ^A	Setting range is from 10A to 150A. Increment of each click is 10A.









03	AC input voltage range	Appliances (default) 03 	If selected, acceptable AC input voltage range will be within 90-280VAC.
		APl	
		UPS 03 	If selected, acceptable AC input voltage range will be within 170-280VAC.
		UPS	
05	Battery type	AGM (default) 05 	Flooded 05 
		AGm	FLd
		User-Defined 05 	If "User-Defined" is selected, battery charge voltage and low DC cut-off voltage can be set up in program 26, 27 and 29.
		USE	
		Pylontech battery 05 	If selected, programs of 02, 26, 27 and 29 will be automatically set up. No need for further setting.
		PYL	
		WECO battery 05 	If selected, programs of 02, 12, 26, 27 and 29 will be auto-configured per battery supplier recommended. No need for further adjustment.
		WEC	
		Soltaro battery 05 	If selected, programs of 02, 26, 27 and 29 will be automatically set up. No need for further setting.
		SOL	
		Lib-protocol compatible battery 05 	Select " Lib" if using Lithium battery compatible to Lib protocol. If selected, programs of 02, 26, 27 and 29 will be automatically set up. No need for further setting.
		LI b	









		3 rd party Lithium battery 05  LIC	Select "LIC" if using Lithium battery not listed above. If selected, programs of 02, 26, 27 and 29 will be automatically set up. No need for further setting. Please contact the battery supplier for installation procedure.
06	Auto restart when overload occurs	Restart disable (default) 06  Lfd	Restart enable 06  LFE
07	Auto restart when over temperature occurs	Restart disable (default) 07  tfd	Restart enable 07  tFE
09	Output frequency	50Hz (default) 09  50 _{Hz}	60Hz 09  60 _{Hz}
10	Output voltage	220V 10  220 _v	230V (default) 10  230 _v
		240V 10  240 _v	
11	Maximum utility charging current Note: If setting value in program 02 is smaller than that in program in 11, the inverter will apply charging current from program 02 for utility charger.	2A 11  U61 2 ^A	30A (default) 11  U61 30 ^A
		Setting range is 2A, then from 10A to 150A. Increment of each click is 10A.	









12	Setting voltage point or SOC percentage back to utility source when selecting "SBU" (SBU priority) in program 01.	46V (default) 12  BATT 46 ^v	Setting range is from 44V to 56V. Increment of each click is 1V.
		SOC 10% (default for Lithium) 12  SOC BATT 10%	If the battery type (#05) set as Lithium, this setting will change to SOC automatically. Adjustable range is 5% to 95%. Increment of each click is 5%.
13	Setting voltage point or SOC percentage back to battery mode when selecting "SBU" (SBU priority) in program 01.	Battery fully charged 13  BATT FUL ^v	54V (default) 13  BATT 54 ^v
		Setting range is from 48V to 62V. Increment of each click is 1V. SOC 30% (default for Lithium) 13  SOC BATT 30%	If any types of lithium battery is selected in program 05, setting value will change to SOC automatically. Setting range is 10% to 100%.
16	Charger source priority: To configure charger source priority	If this inverter/charger is working in Line, Standby or Fault mode, charger source can be programmed as below:	
		Solar first 16  CSO	Solar energy will charge battery as first priority. Utility will charge battery only when solar energy is not available.
		Solar and Utility (default) 16  SNU	Solar energy and utility will charge battery at the same time.
		Only Solar 16  OSO	Solar energy will be the only charger source no matter utility is available or not.













		If this inverter/charger is working in Battery mode, only solar energy can charge battery. Solar energy will charge battery if it's available and sufficient.	
18	Alarm control	Alarm on (default) 18  60N	Alarm off 18  60F
19	Auto return to default display screen	Return to default display screen (default) 19  ESP	If selected, no matter how users switch display screen, it will automatically return to default display screen (Input voltage /output voltage) after no button is pressed for 1 minute.
		Stay at latest screen 19  LEP	If selected, the display screen will stay at latest screen user finally switches.
20	Backlight control	Backlight on (default) 20  LON	Backlight off 20  LOF
22	Beeps while primary source is interrupted	Alarm on (default) 22  AON	Alarm off 22  AOF
23	Overload bypass: When enabled, the unit will transfer to line mode if overload occurs in battery mode.	Bypass disable (default) 23  BYD	Bypass enable 23  BYE





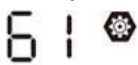



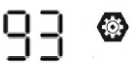
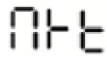
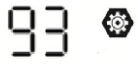
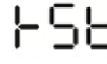

25	Record Fault code	Record enable (default) 25  FEN	Record disable 25  Fd5
26	Bulk charging voltage (C.V voltage)	default: 56.4V 26  CV BATT 56.4V	
27	Floating charging voltage	default: 54.0V 27  FLV BATT 54.0V	
28	AC output mode *This setting is only available when the inverter is in standby mode (Switch off).	Single: This inverter is used in single phase application. 28  S10	Parallel: This inverter is operated in parallel system. 28  PAL
		When the inverter is operated in 3-phase application, set up inverter to be operated in specific phase.	
		L1 phase: 28  3P1	L2 phase: 28  3P2
		L3 phase: 28  3P3	

29	<p>Low DC cut-off voltage or Low SOC:</p> <ul style="list-style-type: none"> ● If battery power is only power source available, inverter will shut down. ● If PV energy and battery power are available, inverter will charge battery without AC output. ● If PV energy, battery power and utility are all available, inverter will transfer to line mode and provide output power to loads. 	<p>default: 44.0V</p> <p>29 </p> <p>CO4</p> <p>BATT</p> <p>44.0_v</p>	<p>If self-defined is selected in program 5, this program can be set up. Setting range is from 42.0V to 48.0V. Increment of each click is 0.1V. Low DC cut-off voltage will be fixed to setting value no matter what percentage of load is connected.</p>
		<p>SOC 0% (default for Lithium)</p> <p>29 </p> <p>SOC</p> <p>BATT</p> <p>0%</p>	<p>If any types of lithium battery is selected in program 05, setting value will change to SOC automatically. Adjustable range is 0% to 90%. Increment of each click is 5%.</p>
30	Battery equalization	<p>Battery equalization</p> <p>30 </p> <p>EEN</p>	<p>Battery equalization disable (default)</p> <p>30 </p> <p>Ed5</p>
		<p>If "Flooded" or "User-Defined" is selected in program 05, this program can be set up.</p>	
31	Battery equalization voltage	<p>default: 58.4V</p> <p>31 </p> <p>EV</p> <p>BATT</p> <p>58.4_v</p>	<p>Setting range is from 48.0V to 62.0V. Increment of each click is 0.1V.</p>
33	Battery equalized time	<p>60min (default)</p> <p>33 </p> <p>60</p>	<p>Setting range is from 5min to 900min. Increment of each click is 5min.</p>
34	Battery equalized timeout	<p>120min (default)</p> <p>34 </p> <p>120</p>	<p>Setting range is from 5min to 900 min. Increment of each click is 5 min.</p>
35	Equalization interval	<p>30days (default)</p> <p>35 </p> <p>30d</p>	<p>Setting range is from 0 to 90 days. Increment of each click is 1 day</p>

36	Equalization activated immediately	Enable 36  AEN	Disable (default) 36  AdS
If equalization function is enabled in program 30, this program can be set up. If "Enable" is selected in this program, it's to activate battery equalization immediately and LCD main page will show "E9". If "Disable" is selected, it will cancel equalization function until next activated equalization time arrives based on program 35 setting. At this time, "E9" will not be shown in LCD main page.			
37	Reset all stored data for PV generated power and output load energy	Not reset(Default) 37  nTe	Reset 37  rSt
41	Maximum battery discharging current	Disable (Default) 41  dds	If selected, battery discharge protection is disabled.
		30A 41  30	The setting range is from 30 A to 200 A. Increment of each click is 10A. If discharging current is higher than setting value, battery will stop discharging. At this time, if the utility is available, the inverter will operate in bypass mode. If no utility is available, the inverter will shut down after 5-minute operation in battery mode.
51	On/Off control for RGB LED *It's necessary to enable this setting to activate RGB LED lighting function.	Enabled (default) 51  LEN	Disable 51  LdS

52	Brightness of RGB LED	Low 52  LO	Normal (default) 52  NOF
		High 52  HI	
53	Lighting speed of RGB LED	Low 53  LO	Normal (default) 53  NOF
		High 53  HI	
54	RGB LED effects	Scrolling 54  SCF	Breathing 54  BRE
		Solid on (Default) 54  SOL	



55	<p>Color combination of RGB LED to show energy source and battery charge/discharge status:</p> <ul style="list-style-type: none"> ● Grid-PV-Battery ● Battery charge/discharge status 	<p>C01: (Default)</p> <ul style="list-style-type: none"> ● Violet-White-Sky blue ● Pink-Honey  	<p>C02:</p> <ul style="list-style-type: none"> ● White-Yellow-Green ● Royal blue-Lime yellow  
60	<p>Setting cut-off voltage point or SOC percentage on the second output (L2) if "Single" is selected in program 28.</p>	<p>default setting: 42.0V</p>   <p>SOC 0% (default for Lithium)</p>  	<p>If "User-defined" is selected in program 05, this setting range is from 42.0V to 61.0V for 48V model. Increment of each click is 0.1V.</p> <p>If any type of lithium battery is selected in program 05, this parameter value will be displayed in percentage and value setting is based on battery capacity percentage. Setting range is from 0% to 95%. Increment of each click is 5%.</p>
61	<p>Setting discharge time on the second output (L2) if "Single" is selected in program 28.</p>	<p>Disable (Default)</p>  	<p>Setting range is disable and then from 0 min to 990 min. Increment of each click is 5 min. *If the battery discharge time achieves the setting time in program 61 and the program 60 function is not triggered, the output will be turned off.</p>
62	<p>Setting time interval for turn on second output (L2) if "Single" is selected in program 28.</p>	<p>00~23 (Default)</p>   	<p>Setting range is from 00 to 23. Increment of each click is 1 hour. If setting range is from 00 to 08, the second output will be turned on until 09:00. During this period, it will be turned off if any setting value in program 60 or 61 is reached.</p>
93	<p>Erase all data log</p>	<p>Not reset (Default)</p>  	<p>Reset</p>  





94	Data log recorded interval *The maximum data log number is 1440. If it's over 1440, it will re-write the first log.	3 minutes 94  3	5 minutes 94  5
		10 minutes (default) 94  10	20 minutes 94  20
		30 minutes 94  30	60 minutes 94  60
95	Time setting – Minute	For minute setting, the range is from 0 to 59. 95  mi n 0	
96	Time setting – Hour	For hour setting, the range is from 0 to 23. 96  HOU 0	
97	Time setting– Day	For day setting, the range is from 1 to 31. 97  DAY 1	
98	Time setting– Month	For month setting, the range is from 1 to 12. 98  MON 1	
99	Time setting – Year	For year setting, the range is from 17 to 99. 99  YEA 19	

Function Setting













There are three function keys on the display panel to implement special functions such as USB OTG, Timer setting for output source priority and timer setting for charger source priority.

1. USB Function Setting

Insert an OTG USB disk into the USB port (). Press and hold "/U" button for 3 seconds to enter USB Setup Mode. These functions including inverter firmware upgrade, data log export and internal parameters re-write from the USB disk.

Procedure	LCD Screen
Step 1: Press and hold "  /U" button for 3 seconds to enter USB function setting mode.	
Step 2: Press "  /U", "  " or "  " button to enter the selectable setting programs (detail descriptions in Step 3)..	

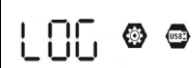
Step 3: Please select setting program by following the procedure.

Program#	Operation Procedure	LCD Screen
 : Upgrade firmware	This function is to upgrade inverter firmware. If firmware upgrade is needed, please check with your dealer or installer for detail instructions.	
 : Re-write internal parameters	This function is to over-write all parameter settings (TEXT file) with settings in the On-The-Go USB disk from a previous setup or to duplicate inverter settings. Please check with your dealer or installer for detail instructions.	
 : Export data log	By pressing "  " button to export data log from the inverter to USB disk. If the selected function is ready, LCD will display "LOG". Press "  /U" button to confirm the selection again.	 
	<ul style="list-style-type: none"> Press "" button to select "Yes", LED 1 will flash once every second during the process. It will only display LOG and all LEDs will be on after this action is complete. Then, press "/U" button to return to main screen. Or press "" button to select "No" to return to main screen. 	  

If no button is pressed for 1 minute, it will automatically return to main screen.





Error message for USB On-the-Go functions:

Error Code	Messages
U01	No USB disk is detected.
U02	USB disk is protected from copy.
U03	Document inside the USB disk with wrong format.

































If any error occurs, error code will only show 3 seconds. After three seconds, it will automatically return to display screen.

2. Timer Setting for Output Source Priority

This timer setting is to set up the output source priority per day.

Procedure	LCD Screen
Step 1: Press and hold  button for 3 seconds to enter Timer Setup Mode for output source priority.	USB 
Step 2: Press  ,  or  button to enter the selectable programs (detail descriptions in Step 3).	SUB SBU





Step 3: Please select setting program by following each procedure.

Program#	Operation Procedure	LCD Screen
	Press  button to set up Utility First Timer. Press  button to select starting time. Press  or  button to adjust values and press  to confirm. Press  button to select end time. Press  or  button to adjust values, press  button to confirm. The setting values are from 00 to 23, with 1-hour increment.	USB  00 23
	Press  button to set up Solar First Timer. Press  button to select starting time. Press  or  button to adjust values and press  to confirm. Press  button to select end time. Press  or  button to adjust values, press  button to confirm. The setting values are from 00 to 23, with 1-hour increment.	SUB  00 23
	Press  button to set up SBU Priority Timer. Press  button to select starting time. Press  or  button to adjust values and press  to confirm. Press  button to select end time. Press  or  button to adjust values, press  button to confirm. The setting values are from 00 to 23, with 1-hour increment.	SBU  00 23

Press  button to exit the Setup Mode.

3. Timer Setting for the Charger Source Priority

This timer setting is to set up the charger source priority per day.

Procedure	LCD Screen
Step 1: Press and hold  button for 3 seconds to enter Timer Setup Mode for charging source priority.	CSO  SNU
Step 2: Press  ,  or  button to enter the selectable programs (detail descriptions in Step 3).	OSO

Step 3: Please select setting program by following each procedure.

Program#	Operation Procedure	LCD Screen
	Press ""/	
	Press ""	
	Press ""	

Press ""/ to exit the Setup Mode.

LCD Display

The LCD display information will be switched in turn by pressing the "UP" or "DOWN" button. The selectable information is switched as the following table in order.

Selectable information	LCD display
Input voltage/Output voltage (Default Display Screen)	<p>Input Voltage=230V, output voltage=230V</p> <p>The LCD display shows 'INPUT AC 230 V' and 'OUTPUT 230 V'. To the right is a system diagram with a 'LOAD' bar at the top, a 'BYPASS' arrow, and a battery 'BATT' bar at the bottom. The diagram includes icons for AC/DC conversion, MPPT, and FCHARGING.</p>
Input frequency	<p>Input frequency=50Hz</p> <p>The LCD display shows 'INPUT AC 500 Hz' and 'OUTPUT 230 V'. The system diagram is similar to the first screen, but the 'LOAD' bar is shorter and the 'BATT' bar is longer.</p>
PV voltage	<p>PV1 voltage=260V</p> <p>The LCD display shows 'PV1' at the top, 'INPUT PV 260 V', and 'OUTPUT 230 V'. The system diagram is similar to the previous screens, but the 'LOAD' bar is very short and the 'BATT' bar is very long.</p>

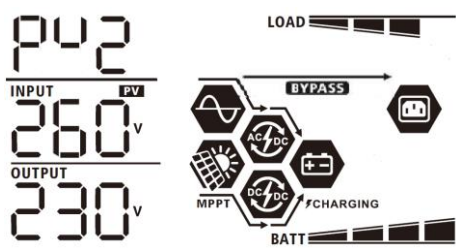
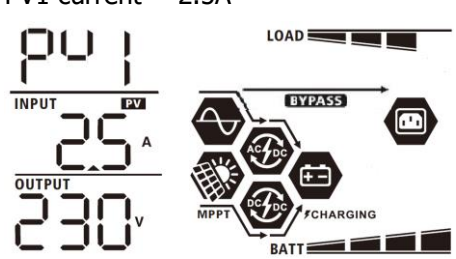
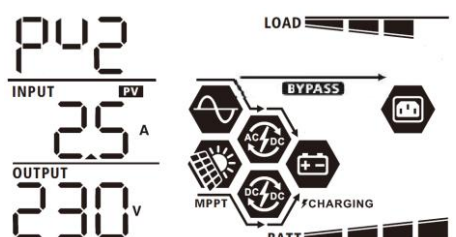
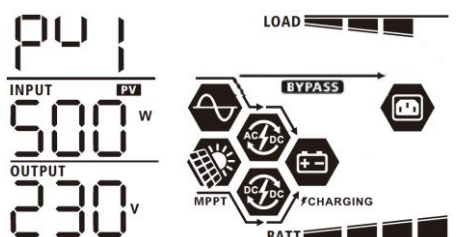
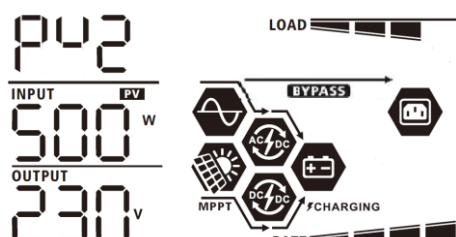
	<p>PV2 voltage=260V</p>  <p>The display shows 'PV2' at the top, 'INPUT PV 260 V', and 'OUTPUT 230 V'. The diagram shows a solar panel connected to an MPPT controller, which is connected to an AC/DC converter, then a DC/DC converter, and finally a BATT (battery) and a CHARGING port. A BYPASS switch is also shown. A LOAD indicator is at the top right.</p>
PV current	<p>PV1 current = 2.5A</p>  <p>The display shows 'PV1' at the top, 'INPUT PV 25 A', and 'OUTPUT 230 V'. The diagram is identical to the PV2 voltage display.</p>
	<p>PV2 current = 2.5A</p>  <p>The display shows 'PV2' at the top, 'INPUT PV 25 A', and 'OUTPUT 230 V'. The diagram is identical to the PV2 voltage display.</p>
PV power	<p>PV1 power = 500W</p>  <p>The display shows 'PV1' at the top, 'INPUT PV 500 W', and 'OUTPUT 230 V'. The diagram is identical to the PV2 voltage display.</p>
	<p>PV2 power = 500W</p>  <p>The display shows 'PV2' at the top, 'INPUT PV 500 W', and 'OUTPUT 230 V'. The diagram is identical to the PV2 voltage display.</p>

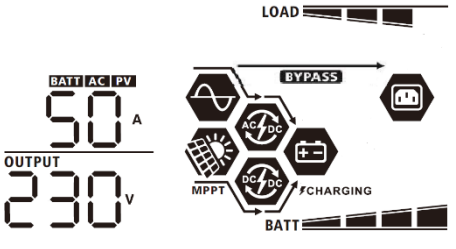
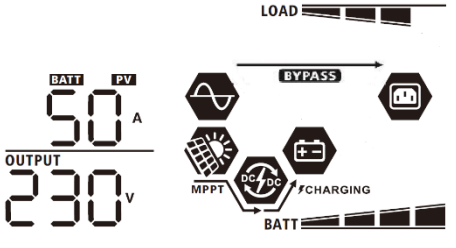
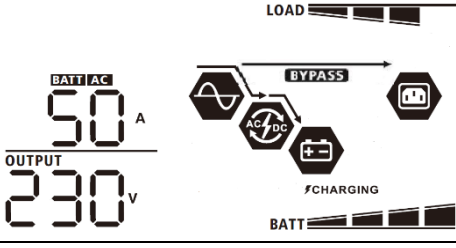
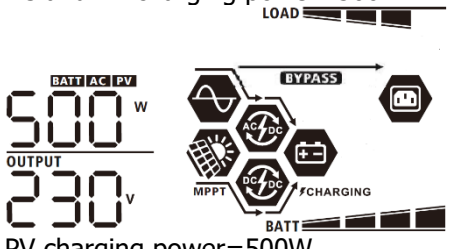
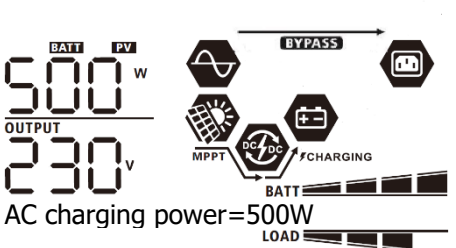
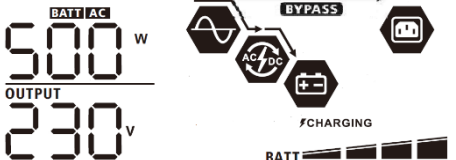
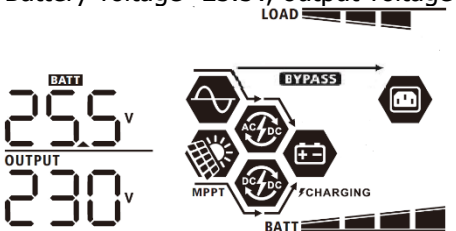

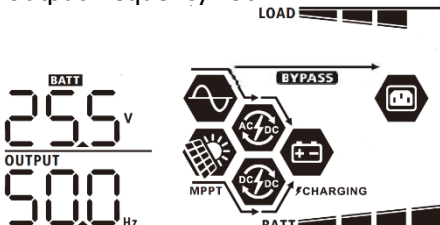
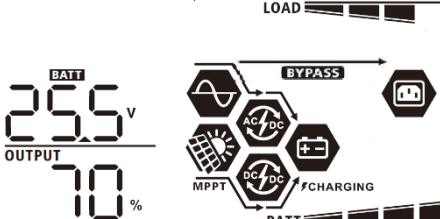
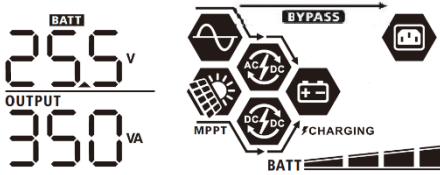
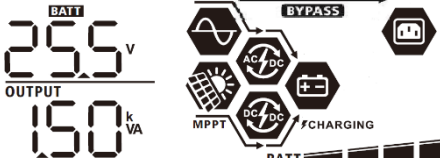
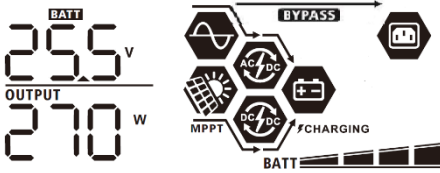
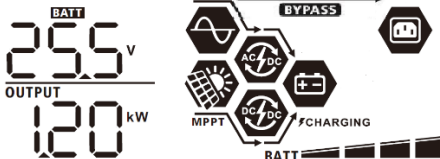

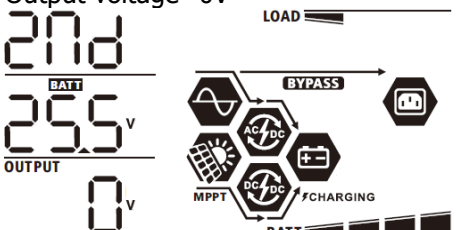
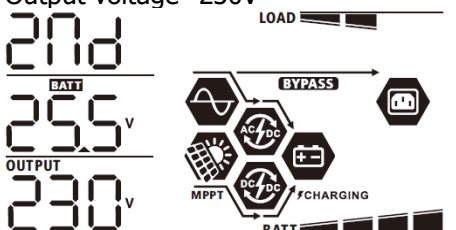
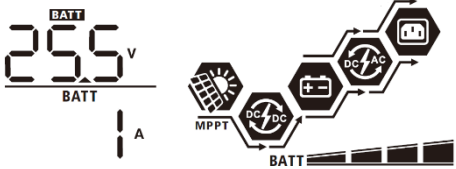
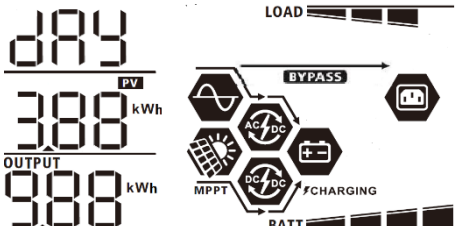
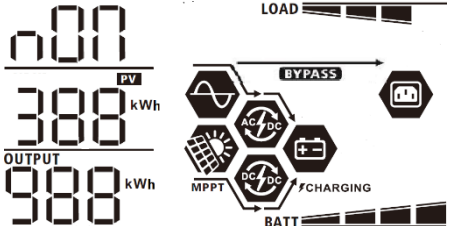
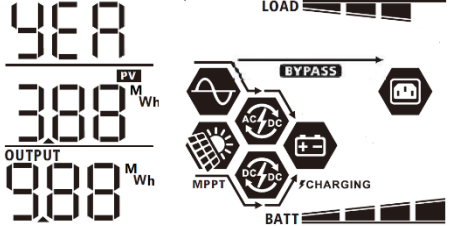
Charging current	<p>AC and PV charging current=50A</p>  <p>PV charging current=50A</p>  <p>AC charging current=50A</p> 
Charging power	<p>AC and PV charging power=500W</p>  <p>PV charging power=500W</p>  <p>AC charging power=500W</p> 
Battery voltage and output voltage	<p>Battery voltage=25.5V, output voltage=230V</p> 

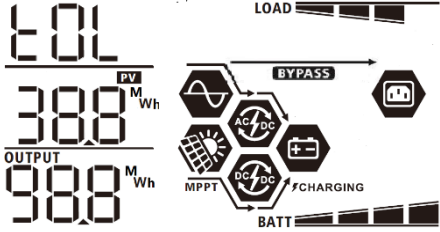
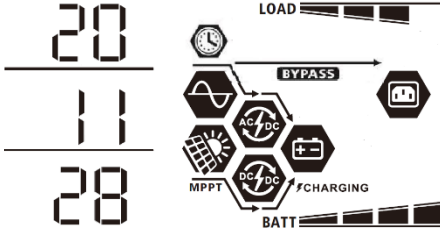
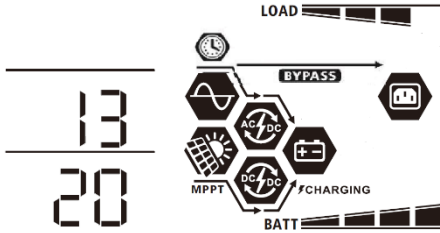
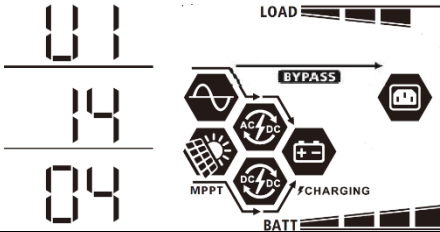
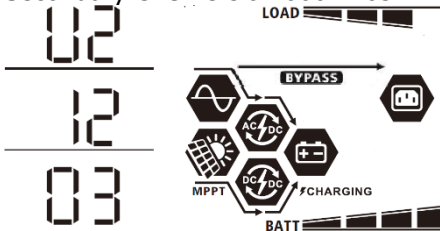
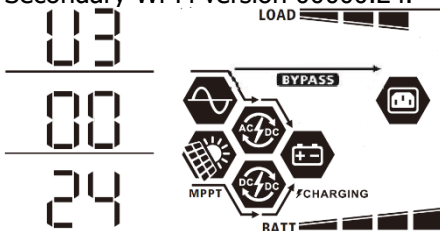

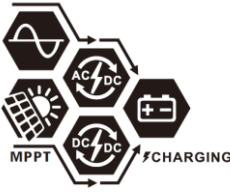

<p>Output frequency</p>	<p>Output frequency=50Hz</p> 
<p>Load percentage</p>	<p>Load percent=70%</p> 
<p>Load in VA</p>	<p>When connected load is lower than 1kVA, load in VA will present xxxVA like below chart.</p>  <p>When load is larger than 1kVA ($\geq 1\text{kVA}$), load in VA will present x.xkVA like below chart.</p> 
<p>Load in Watt</p>	<p>When load is lower than 1kW, load in W will present xxxW like below chart.</p>  <p>When load is larger than 1kW ($\geq 1\text{KW}$), load in W will present x.xkW like below chart.</p> 

<p>2nd Output voltage</p>	<p>The meaning is 2nd output in off status when Output voltage=0V</p>  <p>The meaning is 2nd output in on status when Output voltage=230V</p> 
<p>Battery voltage/DC discharging current</p>	<p>Battery voltage=25.5V, discharging current=1A</p> 
<p>PV energy generated today and Load output energy today</p>	<p>This PV Today energy = 3.88kWh, Load Today energy= 9.88kWh.</p> 
<p>PV energy generated this month and Load output energy this month.</p>	<p>This PV month energy = 388kWh, Load month energy= 988kWh.</p> 
<p>PV energy generated this year and Load output energy this year.</p>	<p>This PV year energy = 3.88MWh, Load year energy = 9.88MWh.</p> 

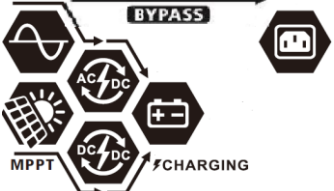
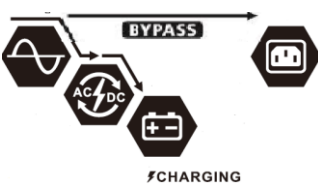
<p>PV energy generated totally and Load output total energy.</p>	<p>PV Total energy = 38.8MWh, Load Output Total energy = 98.8MWh.</p> 
<p>Real date.</p>	<p>Real date Nov 28, 2020.</p> 
<p>Real time.</p>	<p>Real time 13:20.</p> 
<p>Main CPU version checking.</p>	<p>Main CPU version 0014.04.</p> 
<p>Secondary CPU version checking.</p>	<p>Secondary CPU version 0012.03.</p> 
<p>Secondary Wi-Fi version checking.</p>	<p>Secondary Wi-Fi version 00000.24.</p> 

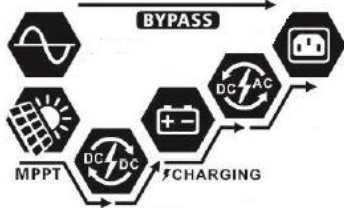
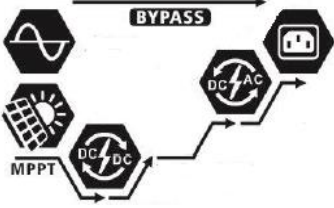
Operating Mode Description

Operation mode	Description	LCD display
<p>Standby mode</p> <p>Note:</p> <p>*Standby mode: The inverter is not turned on yet but at this time, the inverter can charge battery without AC output.</p>	<p>No output is supplied by the unit but it still can charge batteries.</p>	<p>Charging by utility and PV energy.</p> 
		<p>Charging by utility.</p> 
		<p>Charging by PV energy.</p> 
		<p>No charging.</p> 
<p>Fault mode</p> <p>Note:</p> <p>*Fault mode: Errors are caused by inside circuit error or external reasons such as over temperature, output short circuited and so on.</p>	<p>No charging at all no matter if grid or PV power is available.</p>	<p>No charging.</p> 
<p>Line Mode</p>	<p>The unit will provide output power from the mains. It will also charge the battery at line mode.</p>	<p>Charging by utility and PV energy.</p> 
		<p>Charging by utility.</p> 

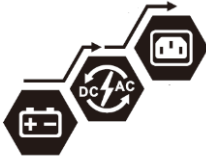











Operation mode	Description	LCD display
Line Mode		<p>If "SUB" (solar first) is selected as output source priority and solar energy is not sufficient to provide the load, solar energy and the utility will provide the loads and charge the battery at the same time.</p> 
	<p>The unit will provide output power from the mains. It will also charge the battery at line mode.</p>	<p>If either "SUB" (solar first) or "SBU" is selected as output source priority and battery is not connected, solar energy and the utility will provide the loads.</p> 
		<p>Power from utility.</p> 
Battery Mode		<p>Power from battery and PV energy.</p> 
	<p>The unit will provide output power from battery and/or PV power.</p>	<p>PV energy will supply power to the loads and charge battery at the same time. No utility is available.</p> 
		<p>Power from battery only.</p> 

Operation mode	Description	LCD display
Battery Mode	The unit will provide output power from battery and/or PV power.	Power from PV energy only. 

Faults Reference Code

Fault Code	Fault Event	Icon on
01	Fan is locked when inverter is off.	F01
02	Over temperature	F02
03	Battery voltage is too high	F03
04	Battery voltage is too low	F04
05	Output short circuited.	F05
06	Output voltage is too high.	F06
07	Overload time out	F07
08	Bus voltage is too high	F08
09	Bus soft start failed	F09
10	PV over current	F10
11	PV over voltage	F11
12	DCDC over current	F12
13	Battery discharge over current	F13
51	Over current	F51
52	Bus voltage is too low	F52
53	Inverter soft start failed	F53
55	Over DC voltage in AC output	F55
57	Current sensor failed	F57
58	Output voltage is too low	F58

Warning Indicator

Warning Code	Warning Event	Audible Alarm	Icon flashing
01	Fan is locked when inverter is on.	Beep three times every second	01 
02	Over temperature	None	02 
03	Battery is over-charged	Beep once every second	03 
04	Low battery	Beep once every second	04 
07	Overload	Beep once every 0.5 second	07  
10	Output power derating	Beep twice every 3 seconds	10 
15	PV energy is low.	Beep twice every 3 seconds	15 
16	High AC input (>280VAC) during BUS soft start	None	16 
32	Communication failure between inverter and remote display panel	None	32 
E9	Battery equalization	None	E9 
bP	Battery is not connected	None	bP 

BATTERY EQUALIZATION

Equalization function is added into charge controller. It reverses the buildup of negative chemical effects like stratification, a condition where acid concentration is greater at the bottom of the battery than at the top. Equalization also helps to remove sulfate crystals that might have built up on the plates. If left unchecked, this condition, called sulfation, will reduce the overall capacity of the battery. Therefore, it's recommended to equalize battery periodically.

- **How to Apply Equalization Function**

You must enable battery equalization function in monitoring LCD setting program 33 first. Then, you may apply this function in device by either one of following methods:

1. Setting equalization interval in program 37.
2. Active equalization immediately in program 39.

- **When to Equalize**

In float stage, when the setting equalization interval (battery equalization cycle) is arrived, or equalization is active immediately, the controller will start to enter Equalize stage.

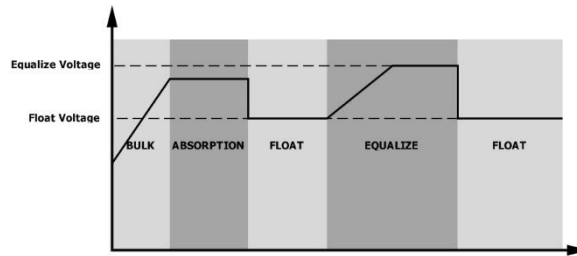

- **Equalize charging time and timeout**

In Equalize stage, the controller will supply power to charge battery as much as possible until battery voltage raises to battery equalization voltage. Then, constant-voltage regulation is applied to maintain battery voltage at the battery equalization voltage. The battery will remain in the Equalize stage until setting battery equalized time is arrived.

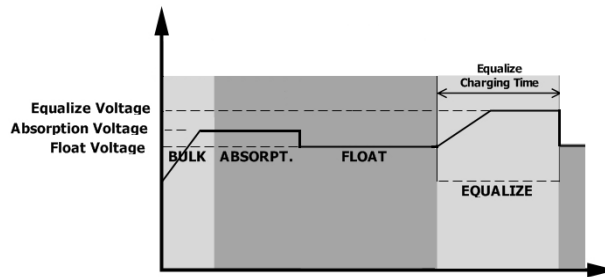

However, in Equalize stage, when battery equalized time is expired and battery voltage doesn't rise to battery equalization voltage point, the charge controller will extend the battery equalized time until battery voltage achieves battery equalization voltage. If battery voltage is still lower than battery equalization voltage when battery equalized timeout setting is over, the charge controller will stop equalization and return to float stage.

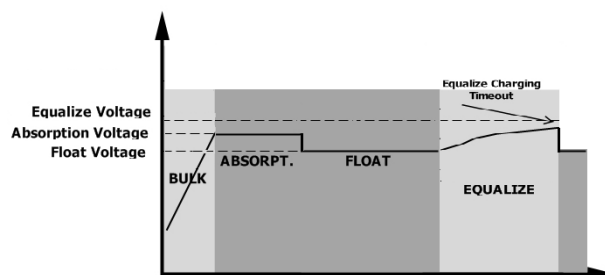

SPECIFICATIONS

Table 1 Line Mode Specifications

MODEL	11KW
Input Voltage Waveform	Sinusoidal (utility or generator)
Nominal Input Voltage	230Vac
Low Loss Voltage	170Vac±7V (UPS) 90Vac±7V (Appliances)
Low Loss Return Voltage	180Vac±7V (UPS); 100Vac±7V (Appliances)
High Loss Voltage	280Vac±7V
High Loss Return Voltage	270Vac±7V
Max AC Input Voltage	300Vac
Max AC Input Current	60A
Max Output Current for 2nd output	40A
Nominal Input Frequency	50Hz / 60Hz (Auto detection)
Low Loss Frequency	40±1Hz
Low Loss Return Frequency	42±1Hz
High Loss Frequency	65±1Hz
High Loss Return Frequency	63±1Hz
Output Short Circuit Protection	Line mode: Circuit Breaker (70A) Battery mode: Electronic Circuits
Efficiency (Line Mode)	>95% (Rated R load, battery full charged)
Transfer Time	10ms typical (UPS); 20ms typical (Appliances)
<p>Output power de-rating: When AC input voltage under 170V the output power will be de-rated.</p>	<p>The graph illustrates the output power de-rating characteristics. The vertical axis represents Output Power, with specific levels for 50% Power and Rated Power. The horizontal axis represents Input Voltage, with key points at 90V, 170V, and 280V. The power remains constant up to 90V, then increases linearly to reach the Rated Power at 170V. It remains constant at Rated Power until 280V, after which it drops to zero.</p>

Table 2 Inverter Mode Specifications

MODEL	11KW
Rated Output Power	11000W
Output Voltage Waveform	Pure Sine Wave
Output Voltage Regulation	230Vac±5%
Output Frequency	60Hz or 50Hz
Peak Efficiency	93%
Overload Protection	100ms@≥180% load;5s@≥120% load; 10s@105%~120% load
Surge Capacity	2* rated power for 5 seconds
Low DC Warning Voltage @ load < 20% @ 20% ≤ load < 50% @ load ≥ 50%	46.0Vdc 42.8Vdc 40.4Vdc
Low DC Warning Return Voltage @ load < 20% @ 20% ≤ load < 50% @ load ≥ 50%	48.0Vdc 44.8Vdc 42.4Vdc
Low DC Cut-off Voltage @ load < 20% @ 20% ≤ load < 50% @ load ≥ 50%	44.0Vdc 40.8Vdc 38.4Vdc
High DC Recovery Voltage	61Vdc
High DC Cut-off Voltage	63Vdc
DC Voltage Accuracy	+/-0.3V@ no load
THDV	<5% for linear load,<10% for non-linear load @ nominal voltage
DC Offset	≤100mV
Power Limitation When battery voltage is lower than 55Vdc, output power will be derated. If connected load is higher than this derated power, the AC output voltage will decrease until the output power reduces to this derated power. The minimum AC output voltage is output voltage setting – 10V.	<p>The graph plots Output Load (Y-axis) against Battery Voltage (X-axis). The X-axis has markers at 42V and 55Vdc. The Y-axis has markers for Rate Power and Rate Power * 0.725. The curve starts at a constant level of Rate Power * 0.725 for battery voltages up to 42V. Between 42V and 55Vdc, the output load increases linearly from Rate Power * 0.725 to Rate Power. For battery voltages above 55Vdc, the output load remains constant at Rate Power.</p>

Table 3 Charge Mode Specifications

Utility Charging Mode		
MODEL	11KW	
Charging Current (UPS) @ Nominal Input Voltage	150A	
Bulk Charging Voltage	Flooded Battery	58.4Vdc
	AGM / Gel Battery	56.4Vdc
Floating Charging Voltage		54Vdc
Overcharge Protection		63Vdc
Charging Algorithm		3-Step
Charging Curve		
Solar Input		
MODEL	11KW	
Rated Power	11000W	
Max. PV Array Open Circuit Voltage	500Vdc	
PV Array MPPT Voltage Range	90Vdc~450Vdc	
Max. Input Current	27A x 2 (MAX 40A)	
Max. Charging Current	150A	
Start-up Voltage	80V +/- 5Vdc	
Power Limitation		

Table 4 General Specifications

MODEL	11KW
Safety Certification	CE
Operating Temperature Range	-10°C to 50°C
Storage temperature	-15°C~ 60°C
Humidity	5% to 95% Relative Humidity (Non-condensing)
Dimension (D*W*H), mm	147.4x 432.5 x 553.6
Net Weight, kg	18.4

Table 5 Parallel Specifications

Max parallel numbers	6
Circulation Current under No Load Condition	Max 2A
Power Unbalance Ratio	<5% @ 100% Load
Parallel communication	CAN
Transfer time in parallel mode	Max 50ms
Parallel Kit	YES

Note: Parallel feature will be disabled when only PV power is available.

TROUBLE SHOOTING

Problem	LCD/LED/Buzzer	Explanation / Possible cause	What to do
Unit shuts down automatically during startup process.	LCD/LEDs and buzzer will be active for 3 seconds and then complete off.	The battery voltage is too low (<1.91V/Cell)	1. Re-charge battery. 2. Replace battery.
No response after power on.	No indication.	1. The battery voltage is far too low. (<1.4V/Cell) 2. Battery polarity is connected reversed.	1. Check if batteries and the wiring are connected well. 2. Re-charge battery. 3. Replace battery.
Mains exist but the unit works in battery mode.	Input voltage is displayed as 0 on the LCD and green LED is flashing.	Input protector is tripped	Check if AC breaker is tripped and AC wiring is connected well.
	Green LED is flashing.	Insufficient quality of AC power. (Shore or Generator)	1. Check if AC wires are too thin and/or too long. 2. Check if generator (if applied) is working well or if input voltage range setting is correct. (UPS→Appliance)
	Green LED is flashing.	Set "Solar First" as the priority of output source.	Change output source priority to Utility first.
When the unit is turned on, internal relay is switched on and off repeatedly.	LCD display and LEDs are flashing	Battery is disconnected.	Check if battery wires are connected well.
Buzzer beeps continuously and red LED is on.	Fault code 07	Overload error. The inverter is overload 110% and time is up.	Reduce the connected load by switching off some equipment.
	Fault code 05	Output short circuited.	Check if wiring is connected well and remove abnormal load.
		Temperature of internal converter component is over 120°C. (Only available for 1-3KVA models.)	Check whether the air flow of the unit is blocked or whether the ambient temperature is too high.
	Fault code 02	Internal temperature of inverter component is over 100°C.	
	Fault code 03	Battery is over-charged.	Return to repair center.
		The battery voltage is too high.	Check if spec and quantity of batteries are meet requirements.
	Fault code 01	Fan fault	Replace the fan.
	Fault code 06/58	Output abnormal (Inverter voltage below than 190Vac or is higher than 260Vac)	1. Reduce the connected load. 2. Return to repair center
	Fault code 08/09/53/57	Internal components failed.	Return to repair center.
	Fault code 51	Over current or surge.	Restart the unit, if the error happens again, please return to repair center.
Fault code 52	Bus voltage is too low.		
Fault code 55	Output voltage is unbalanced.		

Appendix I: Parallel function

1. Introduction

This inverter can be used in parallel with two different operation modes.

1. Parallel operation in single phase is with up to 6 units. The supported maximum output power is 66KW/66KVA.
2. Maximum six units work together to support three-phase equipment. Maximum four units support one phase.

2. Mounting the Unit

When installing multiple units, please follow below chart.

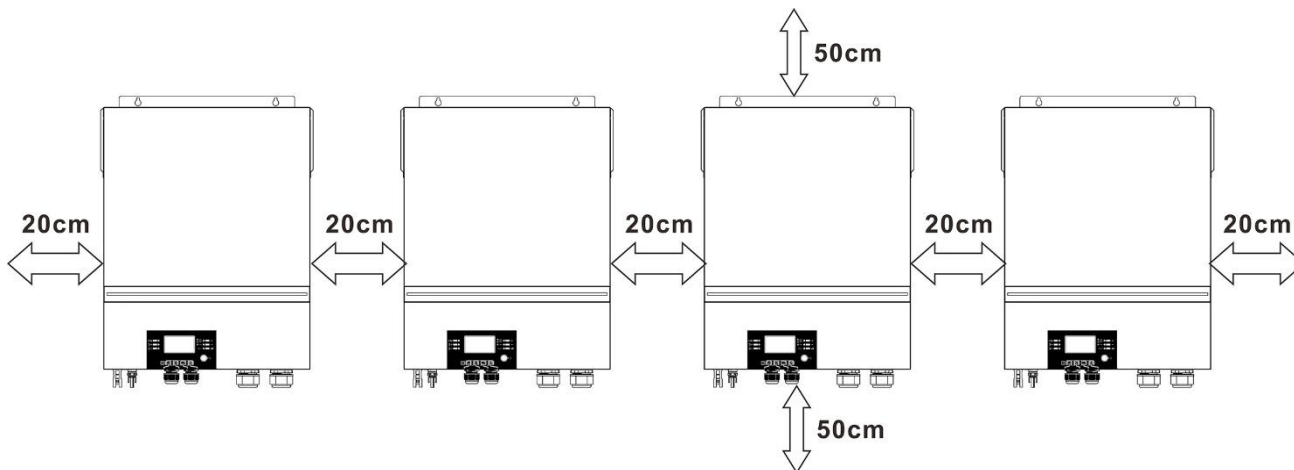

NOTE: For proper air circulation to dissipate heat, allow a clearance of approx. 20 cm to the side and approx. 50 cm above and below the unit. Be sure to install each unit in the same level.

3. Wiring Connection

WARNING: It's REQUIRED to connect battery for parallel operation.

The cable size of each inverter is shown as below:

Recommended battery cable and terminal size for each inverter:

Model	Wire Size	Cable mm ²	Ring Terminal Dimensions		Torque value
			D (mm)	L (mm)	
			11KW	1*3/0AWG	

Ring terminal:

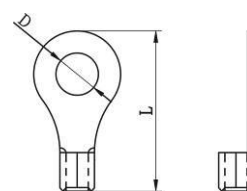

WARNING: Be sure the length of all battery cables is the same. Otherwise, there will be voltage difference between inverter and battery to cause parallel inverters not working.

Recommended AC input and output cable size for each inverter:

Model	AWG no.	Torque
11KW	6 AWG	1.4~ 1.6 Nm

You need to connect the cables of each inverter together. Take the battery cables for example: You need to use a connector or bus-bar as a joint to connect the battery cables together, and then connect to the battery terminal. The cable size used from joint to battery should be X times cable size in the tables above. "X" indicates the number of inverters connected in parallel.

Regarding AC input and output, please also follow the same principle.

CAUTION!! Please install the breaker at the battery and AC input side. This will ensure the inverter can be securely disconnected during maintenance and fully protected from over current of battery or AC input.

Recommended breaker specification of battery for each inverter:

Model	1 unit*
11KW	250A/70VDC

*If you want to use only one breaker at the battery side for the whole system, the rating of the breaker should be X times current of 1 unit. "X" indicates the number of inverters connected in parallel.

Recommended breaker specification of AC input with single phase:

Model	2 units	3 units	4 units	5 units	6 units
11KW	120A/230VAC	180A/230VAC	240A/230VAC	300A/230VAC	360A/230VAC

Note 1: Also, you can use 60A breaker with only 1 unit and install one breaker at its AC input in each inverter.

Note 2: Regarding three-phase system, you can use 4-pole breaker directly and the rating of the breaker should be compatible with the phase current limitation from the phase with maximum units

Recommended battery capacity

Inverter parallel numbers	2	3	4	5	6
Battery Capacity	200AH	400AH	400AH	600AH	600AH

WARNING! Be sure that all inverters will share the same battery bank. Otherwise, the inverters will transfer to fault mode.

4-1. Parallel Operation in Single phase

Two inverters in parallel:

Power Connection

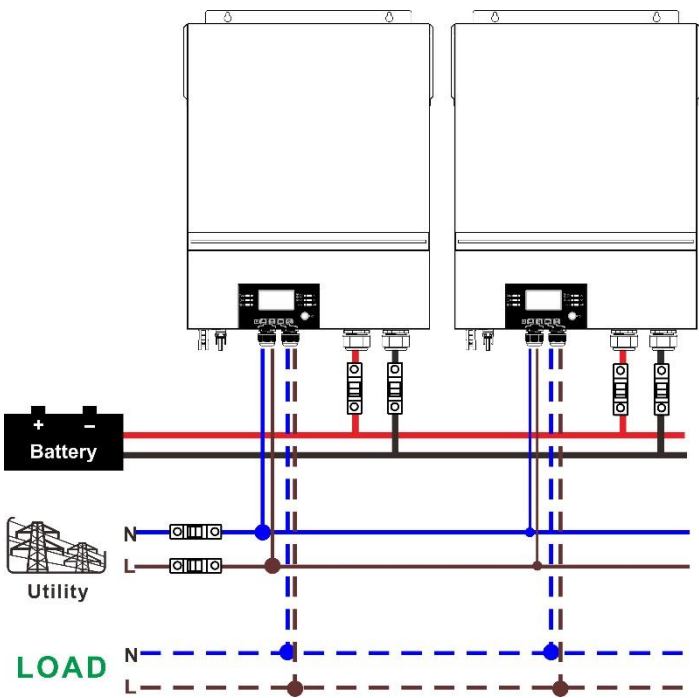

Communication Connection

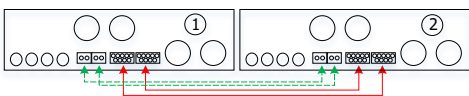

Three inverters in parallel:

Power Connection

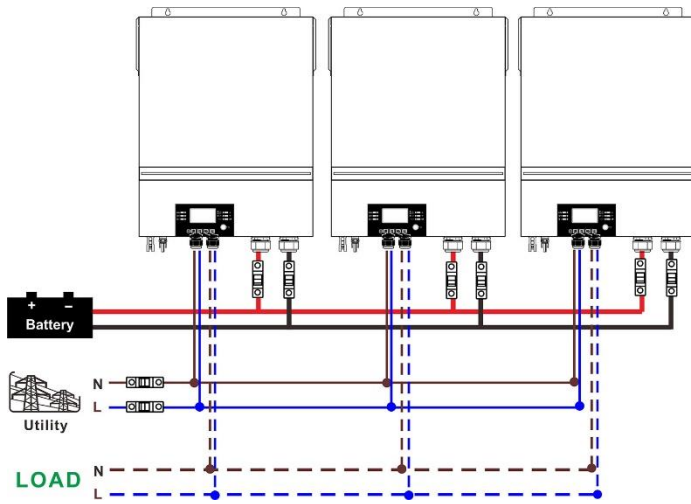

Communication Connection

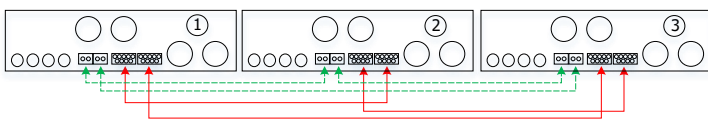

Four inverters in parallel:

Power Connection

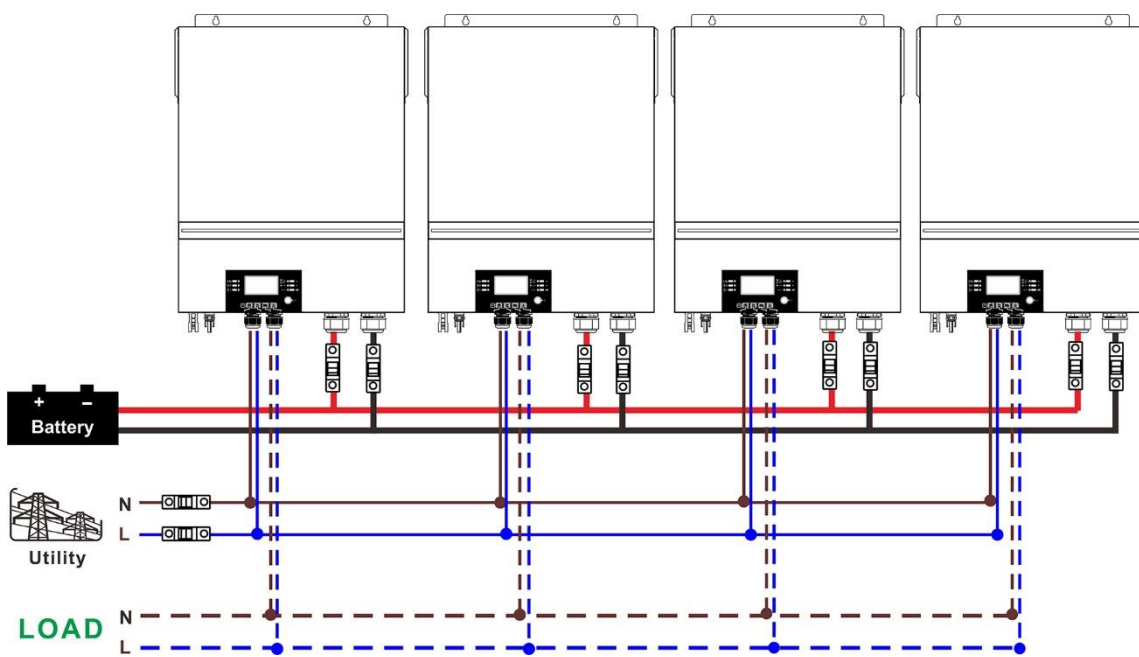

Communication Connection

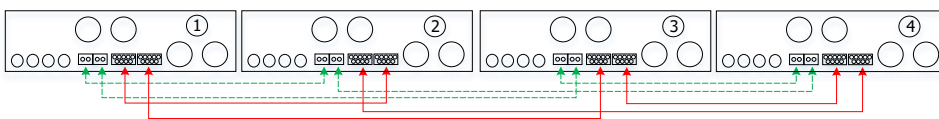

Five inverters in parallel:

Power Connection

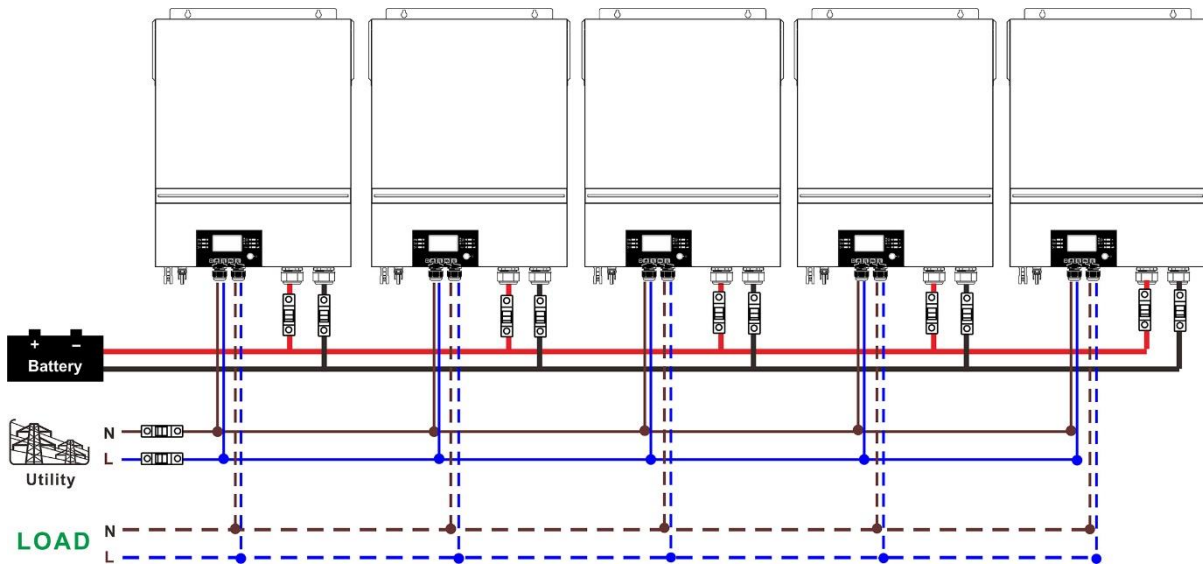

Communication Connection

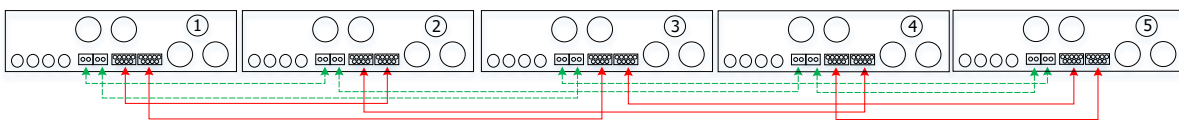

Six inverters in parallel:

Power Connection

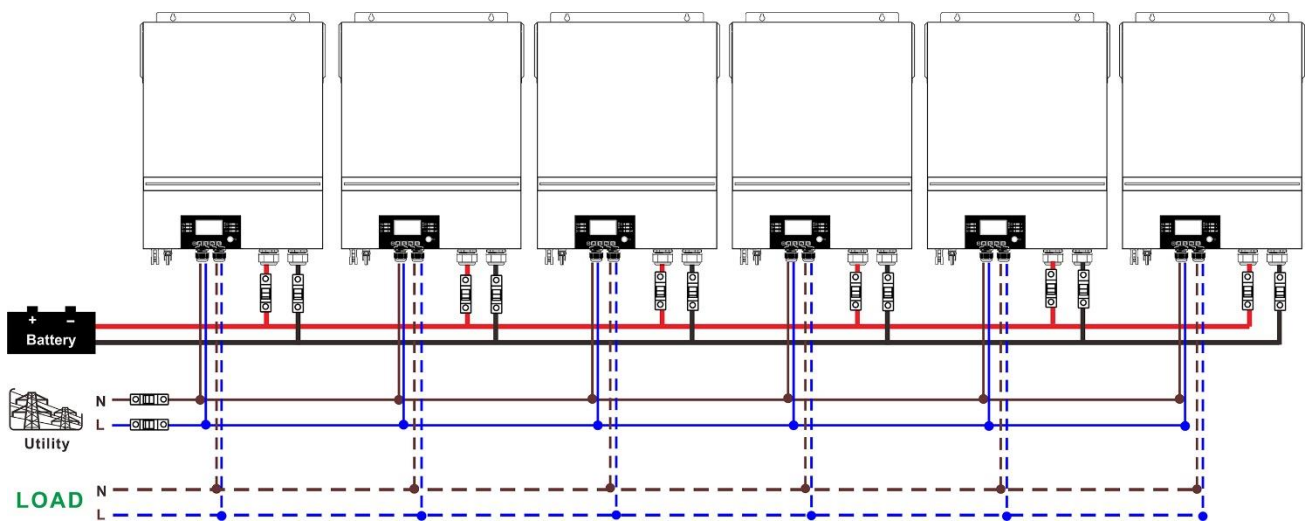

Communication Connection

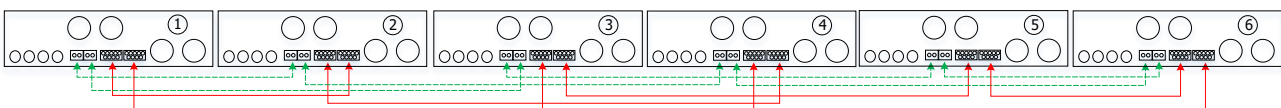

4-2. Support 3-phase equipment

Two inverters in each phase:

Power Connection

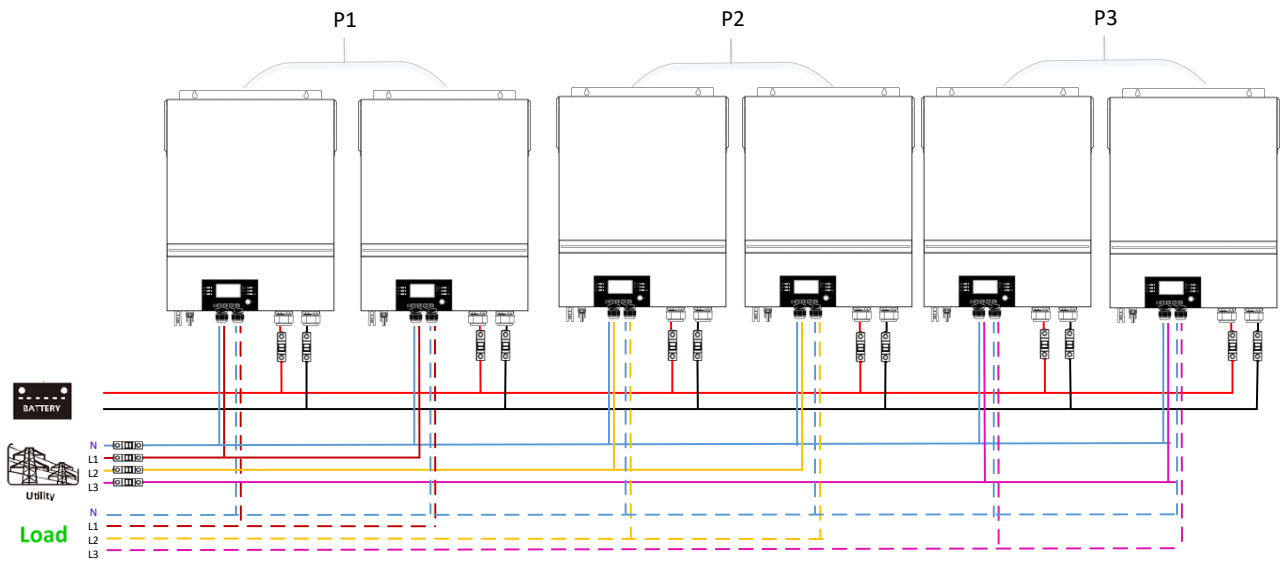

Communication Connection

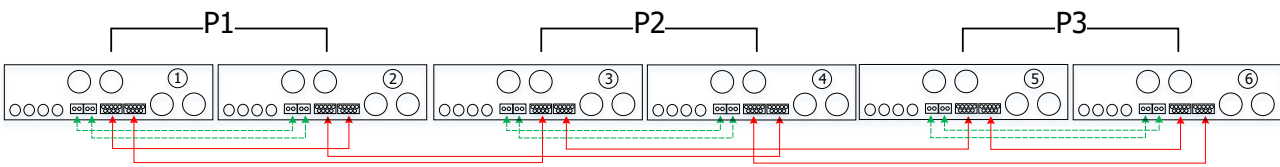

Four inverters in one phase and one inverter for the other two phases:

Power Connection

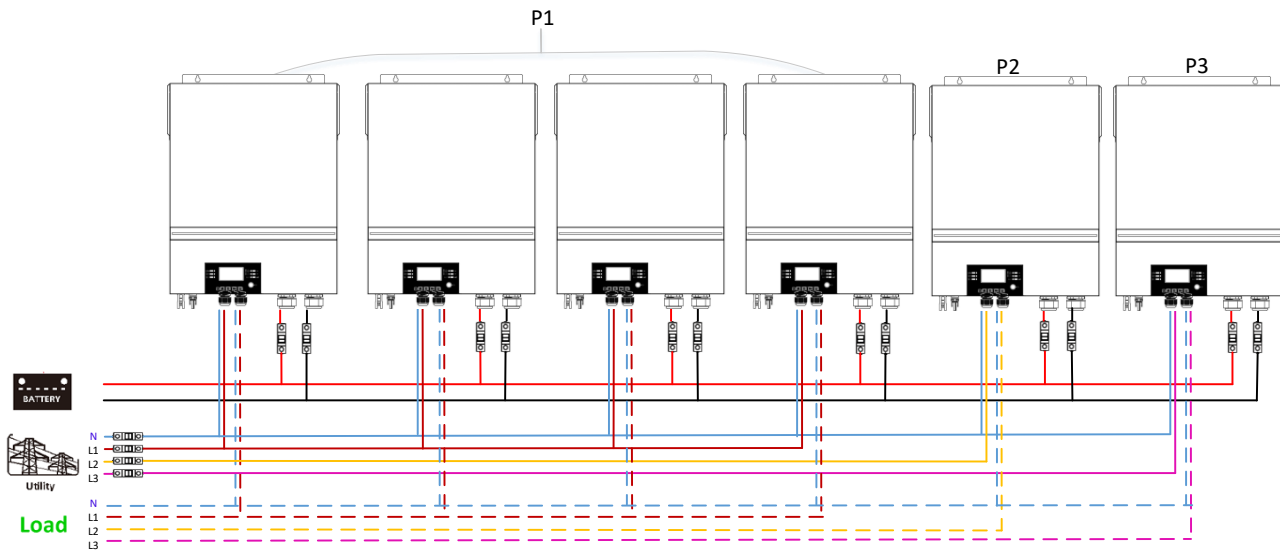

Communication Connection

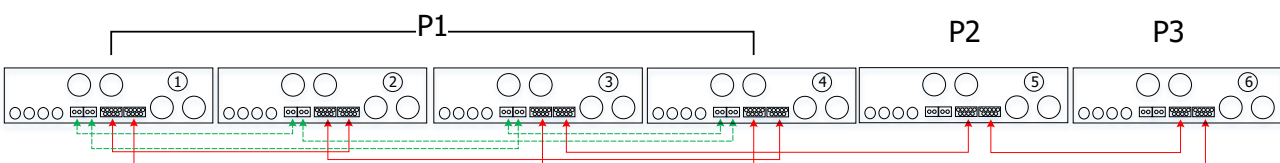

Three inverters in one phase, two inverters in second phase and one inverter for the third phase:

Power Connection

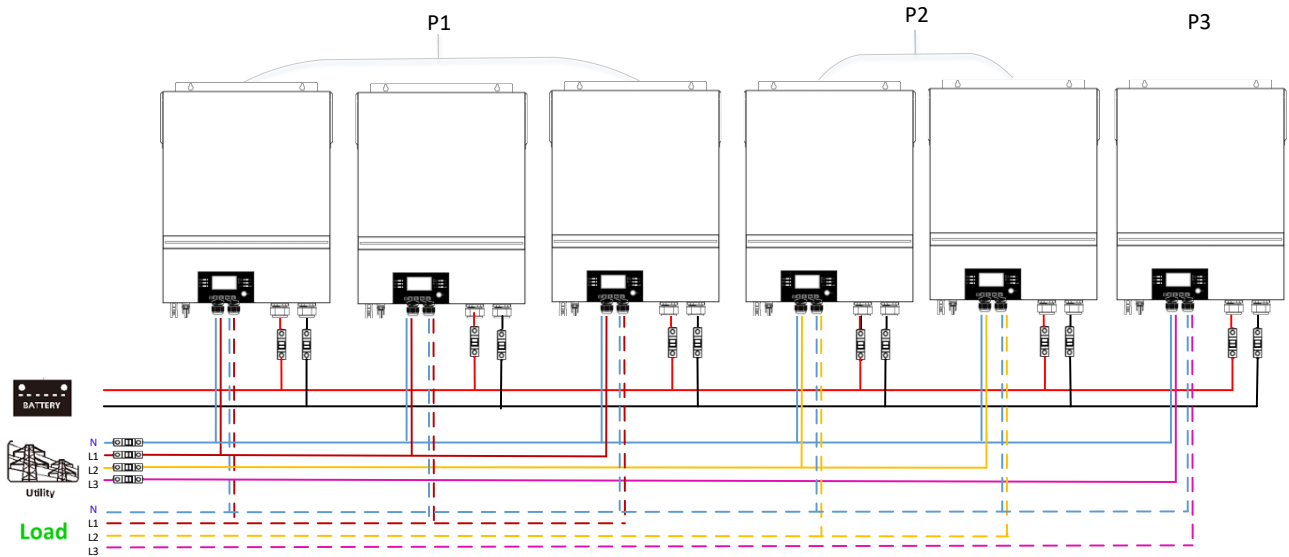

Communication Connection

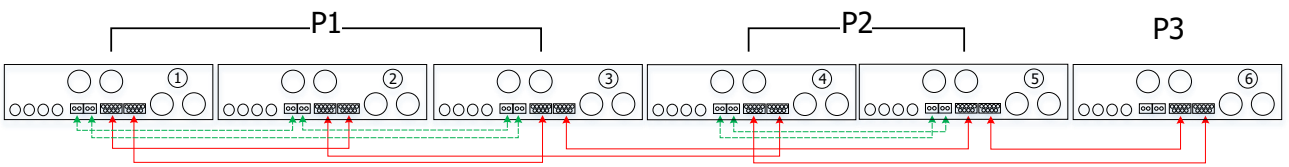

Three inverters in one phase and only one inverter for the remaining two phases:

Power Connection

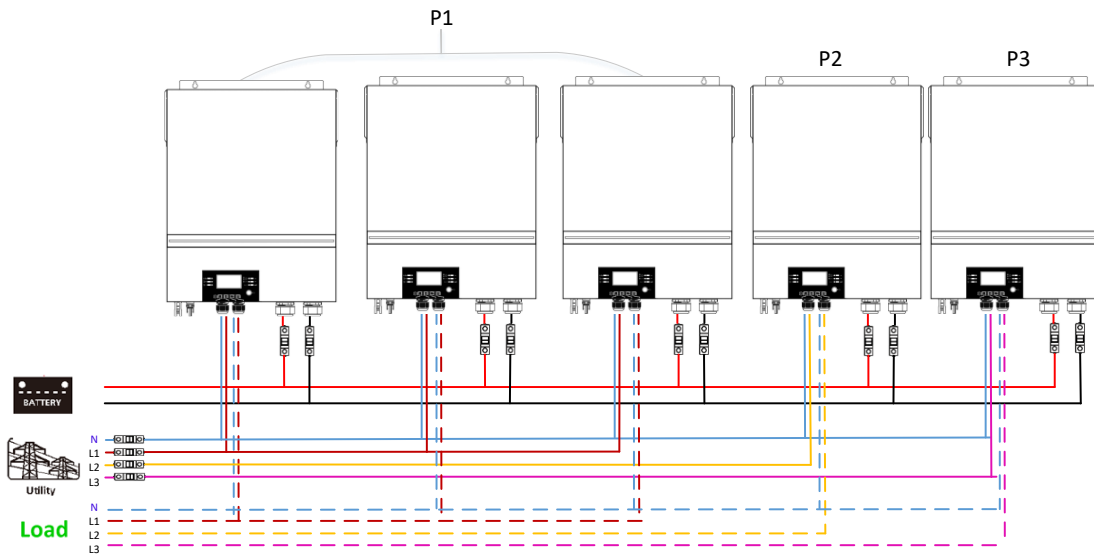

Communication Connection

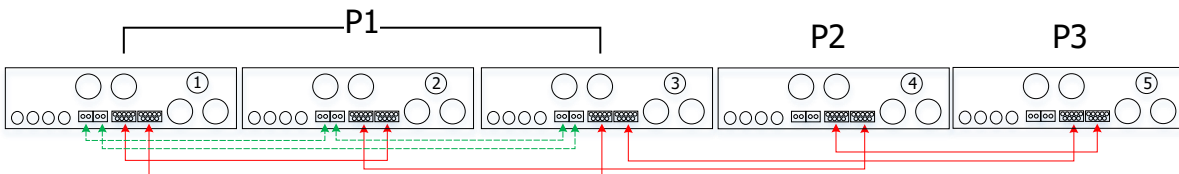

Two inverters in two phases and only one inverter for the remaining phase:

Power Connection

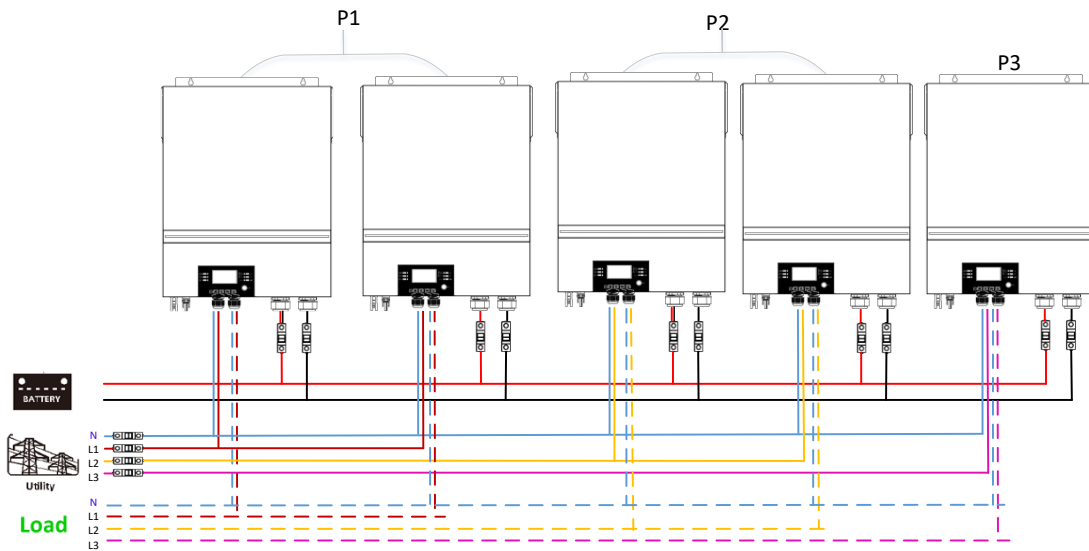

Communication Connection

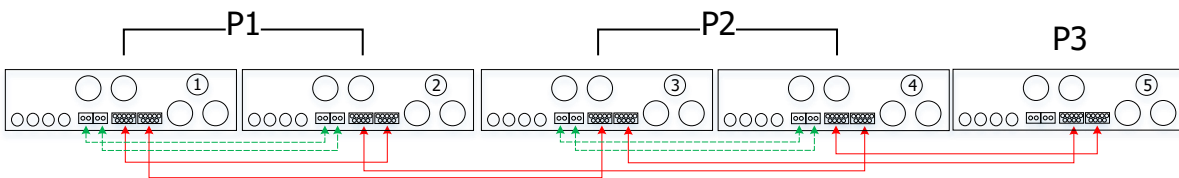

Two inverters in one phase and only one inverter for the remaining phases:

Power Connection

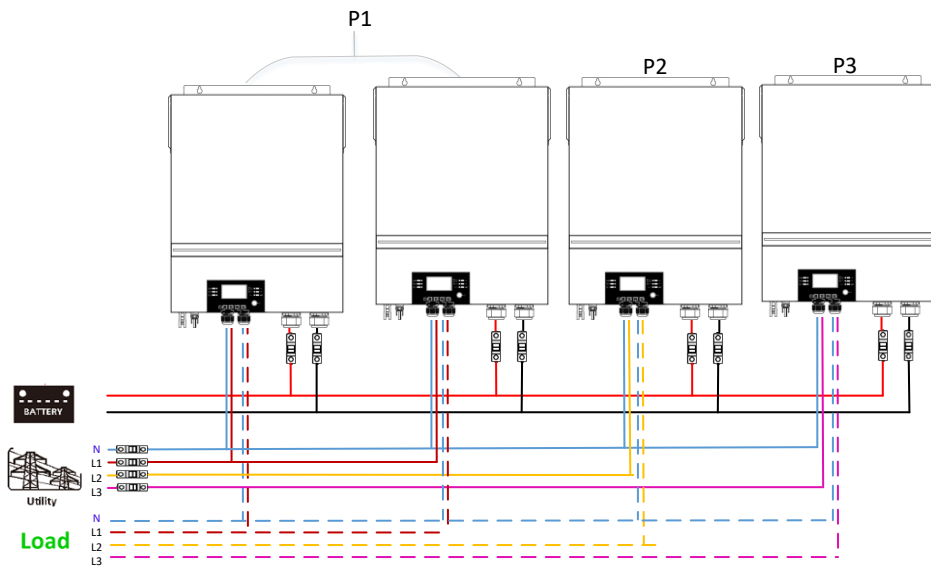

Communication Connection

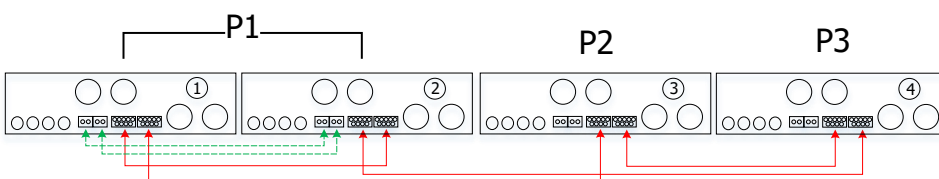

One inverter in each phase:

Power Connection

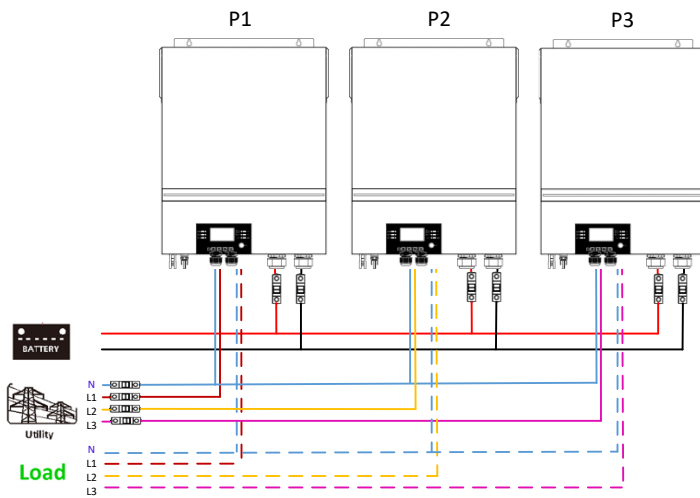

Communication Connection

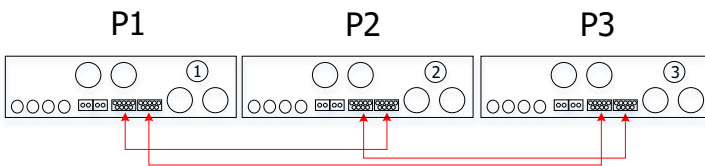

WARNING: Do not connect the current sharing cable between the inverters which are in different phases. Otherwise, it may damage the inverters.





5. PV Connection

Please refer to user manual of single unit for PV Connection.

CAUTION: Each inverter should connect to PV modules separately.

6. LCD Setting and Display

Setting Program:

Program	Description	Selectable option	
28	AC output mode *This setting is able to set up only when the inverter is in standby mode. Be sure that on/off switch is in "OFF" status.	Single 28  SIG	When the unit is operated alone, please select "SIG" in program 28.
		Parallel 28  PAL	When the units are used in parallel for single phase application, please select "PAL" in program 28. Please refer to 5-1 for detailed information.
		L1 phase: 28  3P1	When the units are operated in 3-phase application, please choose "3PX" to define each inverter. It is required to have at least 3 inverters or maximum 6 inverters to support three-phase equipment. It's required to have at least one inverter in each phase or it's up to four inverters in one phase. Please refers to 4-2 for detailed information. Please select "3P1" in program 28 for the inverters connected to L1 phase, "3P2" in program 28 for the inverters connected to L2 phase and "3P3" in program 28 for the inverters connected to L3 phase. Be sure to connect share current cable to units which are on the same phase. Do NOT connect share current cable between units on different phases.
		L2 phase: 28  3P2	
		L3 phase: 28  3P3	

Fault code display:

Fault Code	Fault Event	Icon on
60	Power feedback protection	F60
71	Firmware version inconsistent	F71
72	Current sharing fault	F72
80	CAN fault	F80
81	Host loss	F81
82	Synchronization loss	F82
83	Battery voltage detected different	F83
84	AC input voltage and frequency detected different	F84
85	AC output current unbalance	F85
86	AC output mode setting is different	F86

Code Reference:

Code	Description	Icon on
NE	Unidentified unit master or slave	NE
HS	Master unit	HS
SL	Slave unit	SL

7. Commissioning

Parallel in single phase

Step 1: Check the following requirements before commissioning:

- Correct wire connection
- Ensure all breakers in Line wires of load side are open and each Neutral wires of each unit are connected together.

Step 2: Turn on each unit and set "PAL" in LCD setting program 28 of each unit. And then shut down all units.

NOET: It's necessary to turn off switch when setting LCD program. Otherwise, the setting cannot be programmed.

Step 3: Turn on each unit.

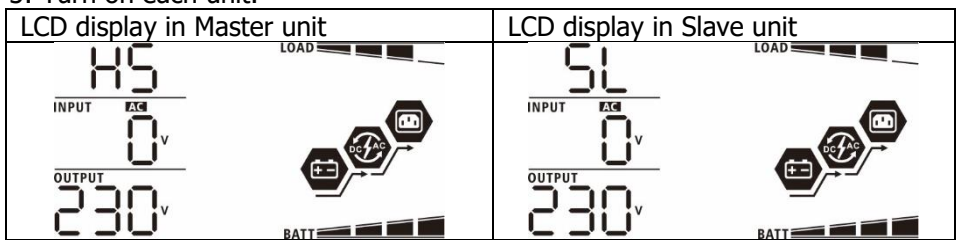

NOTE: Master and slave units are randomly defined.

Step 4: Switch on all AC breakers of Line wires in AC input. It's better to have all inverters connect to utility at

the same time. If not, it will display fault 82 in following-order inverters. However, these inverters will automatically restart. If detecting AC connection, they will work normally.

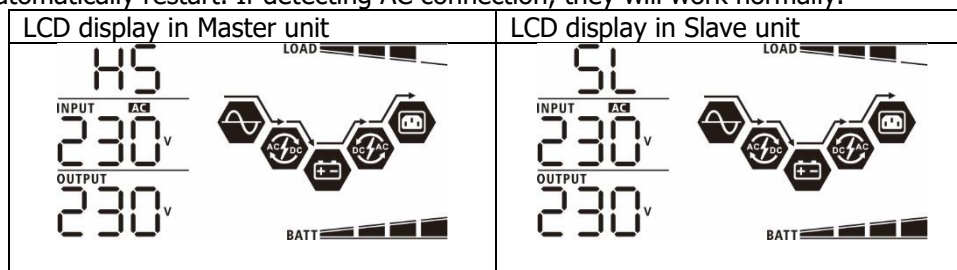

Step 5: If there is no more fault alarm, the parallel system is completely installed.

Step 6: Please switch on all breakers of Line wires in load side. This system will start to provide power to the load.

Support three-phase equipment

Step 1: Check the following requirements before commissioning:

- Correct wire connection
- Ensure all breakers in Line wires of load side are open and each Neutral wires of each unit are connected together.

Step 2: Turn on all units and configure LCD program 28 as P1, P2 and P3 sequentially. And then shut down all units.

NOET: It's necessary to turn off switch when setting LCD program. Otherwise, the setting cannot be programmed.

Step 3: Turn on all units sequentially.

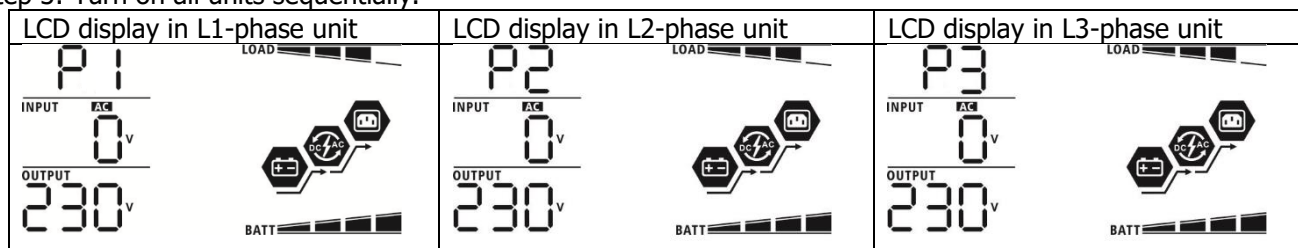

Step 4: Switch on all AC breakers of Line wires in AC input. If AC connection is detected and three phases are matched with unit setting, they will work normally. Otherwise, the AC icon will flash and they will not work in line mode.

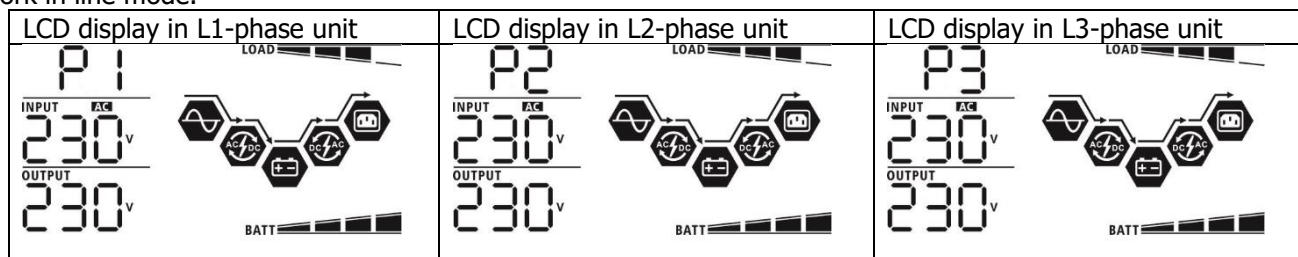

Step 5: If there is no more fault alarm, the system to support 3-phase equipment is completely installed.

Step 6: Please switch on all breakers of Line wires in load side. This system will start to provide power to the load.

Note 1: To avoid overload occurring, before turning on breakers in load side, it's better to have whole system in operation first.

Note 2: Transfer time for this operation exists. Power interruption may happen to critical devices, which cannot bear transfer time.

8. Trouble shooting

Situation		Solution
Fault Code	Fault Description Event	
60	Current feedback into the inverter is detected.	<ol style="list-style-type: none"> Restart the inverter. Check if L/N cables are not connected reversely in all inverters. For parallel system in single phase, make sure the sharing are connected in all inverters. For supporting three-phase system, make sure the sharing cables are connected in the inverters in the same phase, and disconnected in the inverters in different phases. If the problem remains, please contact your installer.
71	The firmware version of each inverter is not the same.	<ol style="list-style-type: none"> Update all inverter firmware to the same version. Check the version of each inverter via LCD setting and make sure the CPU versions are same. If not, please contact your instraller to provide the firmware to update. After updating, if the problem still remains, please contact your installer.
72	The output current of each inverter is different.	<ol style="list-style-type: none"> Check if sharing cables are connected well and restart the inverter. If the problem remains, please contact your installer.
80	CAN data loss	<ol style="list-style-type: none"> Check if communication cables are connected well and restart the inverter. If the problem remains, please contact your installer.
81	Host data loss	
82	Synchronization data loss	
83	The battery voltage of each inverter is not the same.	<ol style="list-style-type: none"> Make sure all inverters share same groups of batteries together. Remove all loads and disconnect AC input and PV input. Then, check battery voltage of all inverters. If the values from all inverters are close, please check if all battery cables are the same length and same material type. Otherwise, please contact your installer to provide SOP to calibrate battery voltage of each inverter. If the problem still remains, please contact your installer.
84	AC input voltage and frequency are detected different.	<ol style="list-style-type: none"> Check the utility wiring connction and restart the inverter. Make sure utility starts up at same time. If there are breakers installed between utility and inverters, please be sure all breakers can be turned on AC input at same time. If the problem remains, please contact your installer.
85	AC output current unbalance	<ol style="list-style-type: none"> Restart the inverter. Remove some excessive loads and re-check load information from LCD of inverters. If the values are different, please check if AC input and output cables are in the same length and material type. If the problem remains, please contact your installer.
86	AC output mode setting is different.	<ol style="list-style-type: none"> Switch off the inverter and check LCD setting #28. For parallel system in single phase, make sure no 3P1, 3P2 or 3P3 is set on #28. For upporting three-phase system, make sure no "PAL" is set on #28. If the problem remains, please contact your installer.

Appendix II: BMS Communication Installation

1. Introduction

If connecting to lithium battery, it is recommended to purchase a custom-made RJ45 communication cable. Please check with your dealer or integrator for details.

This custom-made RJ45 communication cable delivers information and signal between lithium battery and the inverter. These information are listed below:

- Re-configure charging voltage, charging current and battery discharge cut-off voltage according to the lithium battery parameters.
- Have the inverter start or stop charging according to the status of lithium battery.

2. Pin Assignment for BMS Communication Port

	Definition
PIN 1	RS232TX
PIN 2	RS232RX
PIN 3	RS485B
PIN 4	NC
PIN 5	RS485A
PIN 6	CANH
PIN 7	CANL
PIN 8	GND

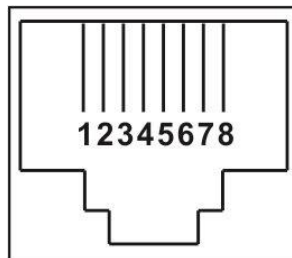

3. Lithium Battery Communication Configuration

LIO-4810-150A

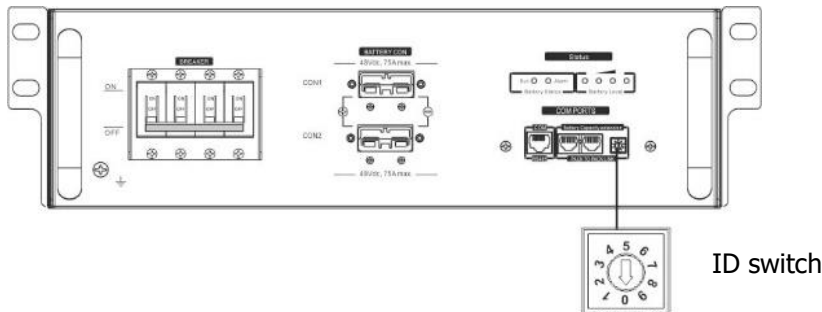

ESS LIO-I 4810

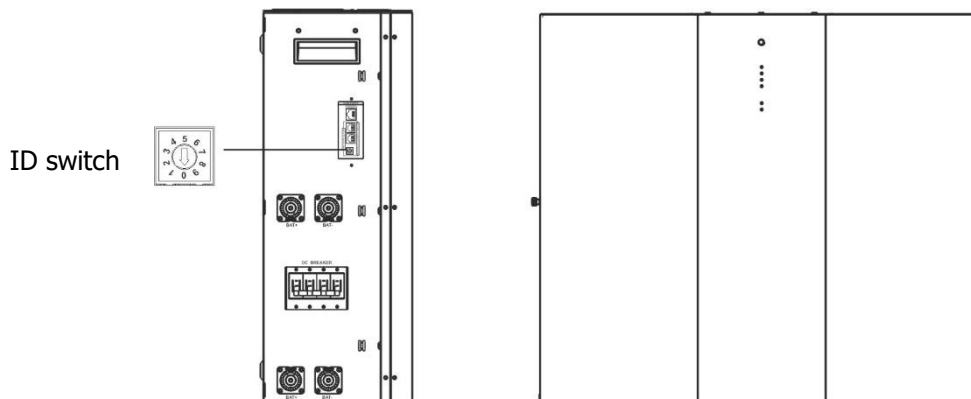

ID Switch indicates the unique ID code for each battery module. It's required to assign a unique ID to each battery module for normal operation. We can set up the ID code for each battery module by rotating the PIN number on the ID switch. From number 0 to 9, the number can be random; no particular order. Maximum 10 battery modules can be operated in parallel.

PYLONTECH

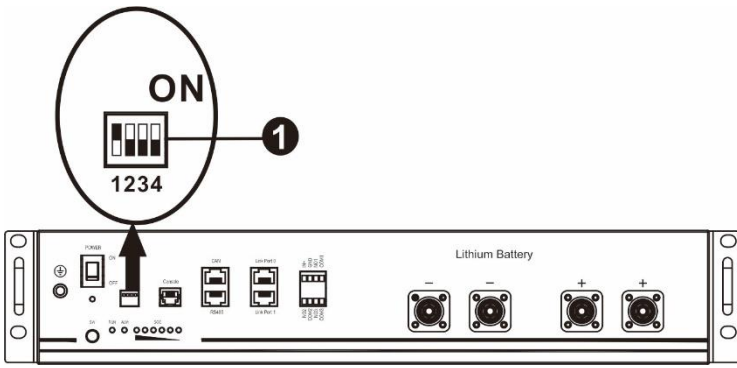

① Dip Switch: There are 4 Dip Switches that sets different baud rate and battery group address. If switch position is turned to the "OFF" position, it means "0". If switch position is turned to the "ON" position, it means "1".

Dip 1 is "ON" to represent the baud rate 9600.

Dip 2, 3 and 4 are reserved for battery group address.

Dip switch 2, 3 and 4 on master battery (first battery) are to set up or change the group address.

NOTE: "1" is upper position and "0" is bottom position.

Dip 1	Dip 2	Dip 3	Dip 4	Group address
1: RS485 baud rate=9600 Restart to take effect	0	0	0	Single group only. It's required to set up master battery with this setting and slave batteries are unrestricted.
	1	0	0	Multiple group condition. It's required to set up master battery on the first group with this setting and slave batteries are unrestricted.
	0	1	0	Multiple group condition. It's required to set up master battery on the second group with this setting and slave batteries are unrestricted.
	1	1	0	Multiple group condition. It's required to set up master battery on the third group with this setting and slave batteries are unrestricted.
	0	0	1	Multiple group condition. It's required to set up master battery on the fourth group with this setting and slave batteries are unrestricted.
	1	0	1	Multiple group condition. It's required to set up master battery on the fifth group with this setting and slave batteries are unrestricted.

NOTE: The maximum groups of lithium battery is 5 and for maximum number for each group, please check with battery manufacturer.

4. Installation and Operation

LIO-4810-150A/ESS LIO-I 4810

After ID no. is assigned for each battery module, please set up LCD panel in inverter and install the wiring connection as following steps.

Step 1: Use supplied RJ11 signal cable to connect into the extension port (P1 or P2).

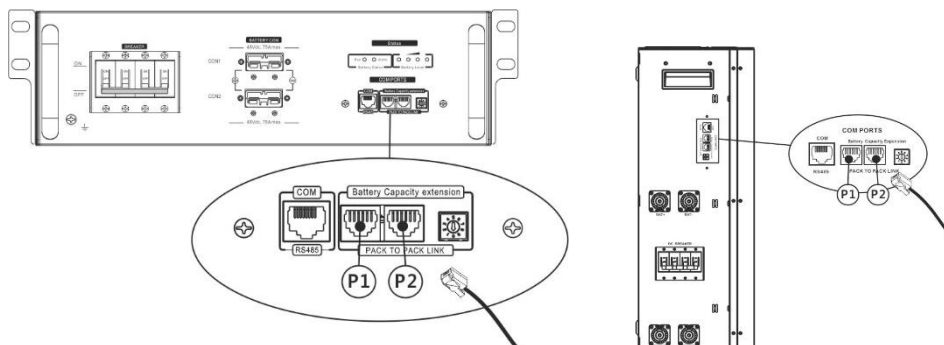

Step 2: Use supplied RJ45 cable (from battery module package) to connect inverter and Lithium battery.

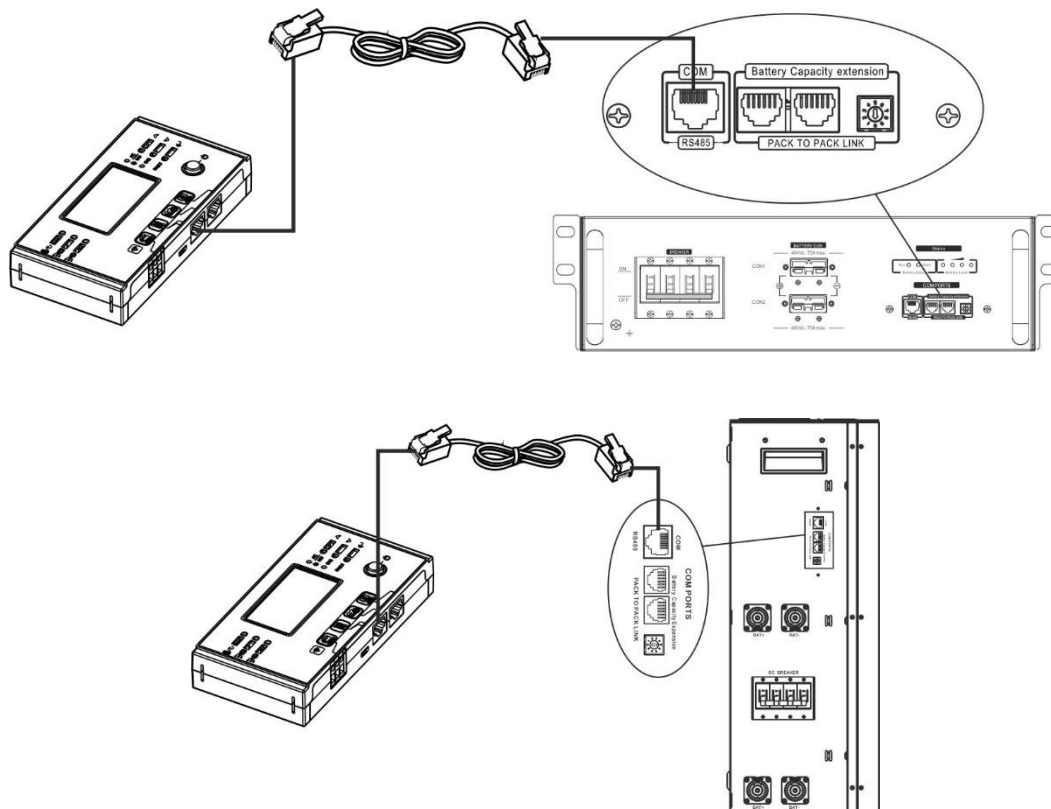

*** For multiple battery connection, please check battery manual for the details.**

Note for parallel system:

1. Only support common battery installation.
2. Use custom-made RJ45 cable to connect any inverter (no need to connect to a specific inverter) and Lithium battery. Simply set this inverter battery type to "LIB" in LCD program 5. Others should be "USE".

Step 3: Turn the breaker switch "ON". Now, the battery module is ready for DC output.

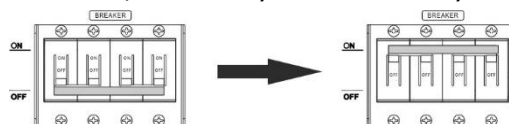

Step 4: Press Power on/off button on battery module for 5 secs, the battery module will start up.

*If the manual button cannot be approached, just simply turn on the inverter module. The battery module will be automatically turned on.

Step 5: Turn on the inverter.

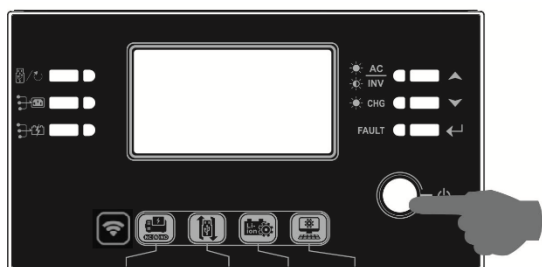

Step 6. Be sure to select battery type as "LIB" in LCD program 5.



If communication between the inverter and battery is successful, the battery icon on LCD display will flash. Generally speaking, it will take longer than 1 minute to establish communication.

PYLONTECH

After configuration, please install LCD panel with inverter and Lithium battery with the following steps.

Step 1. Use custom-made RJ45 cable to connect inverter and Lithium battery.

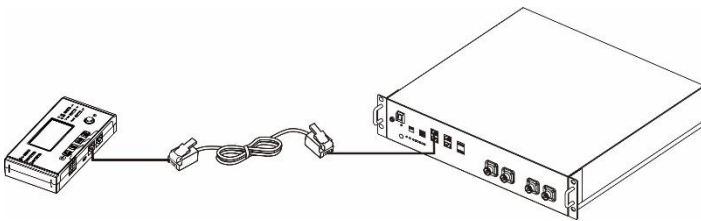

Note for parallel system:

1. Only support common battery installation.
2. Use custom-made RJ45 cable to connect any inverter (no need to connect to a specific inverter) and Lithium battery. Simply set this inverter battery type to "PYL" in LCD program 5. Others should be "USE".

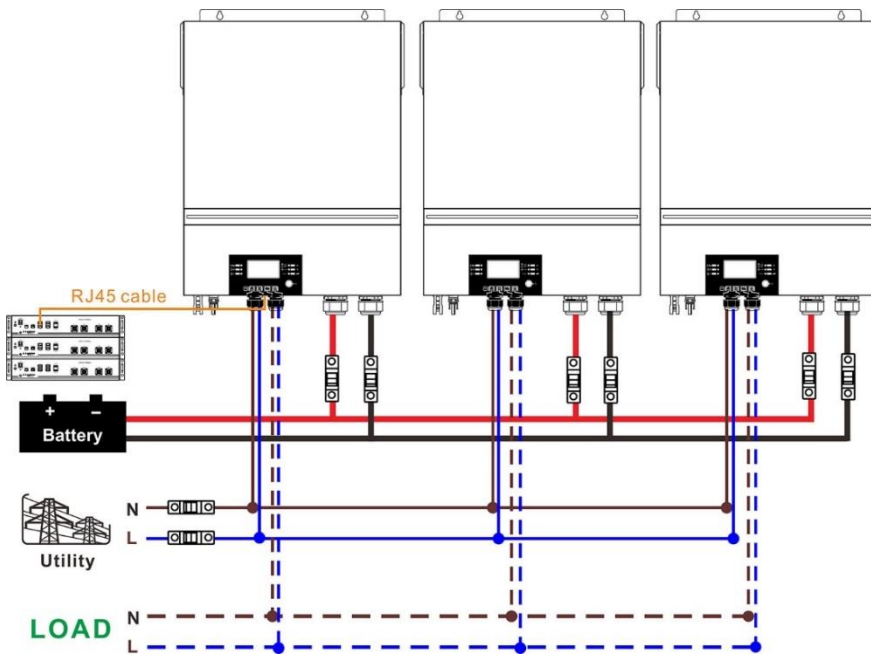

Step 2. Switch on Lithium battery.

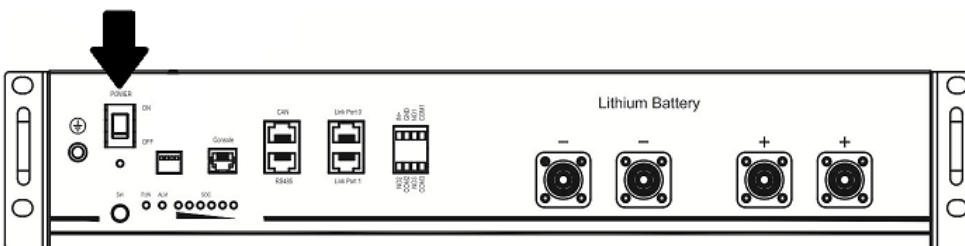

Step 3. Press more than three seconds to start Lithium battery, power output ready.

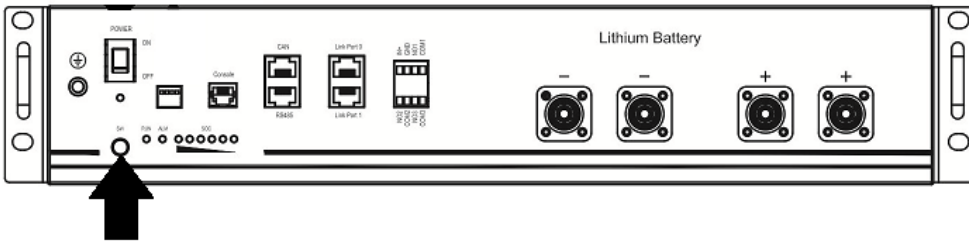

Step 4. Turn on the inverter.

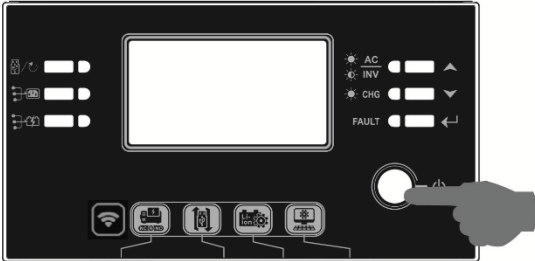

Step 5. Be sure to select battery type as "PYL" in LCD program 5.

05

PYL

If communication between the inverter and battery is successful, the battery icon  on LCD display will flash. Generally speaking, it will take longer than 1 minute to establish communication.

Active Function

This function is to activate lithium battery automatically while commissioning. After battery wiring and commissioning is successfully, if battery is not detected, the inverter will automatically activate battery if the inverter is powered on.





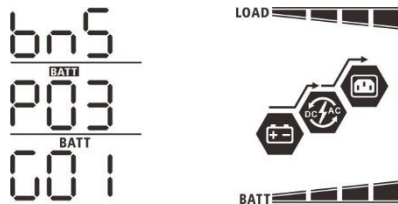

5. LCD Display Information

Press "▲" or "▼" button to switch LCD display information. It will show battery pack and battery group number before "Main CPU version checking" as shown below.

Selectable information	LCD display
Battery pack numbers & Battery group numbers	Battery pack numbers = 3, battery group numbers = 1 

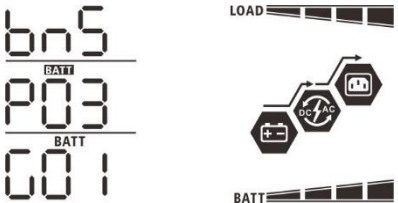
6. Code Reference

Related information code will be displayed on LCD screen. Please check inverter LCD screen for the operation.

Code	Description	Action
60 	If battery status is not allowed to charge and discharge after the communication between the inverter and battery is successful, it will show code 60 to stop charging and discharging battery.	
61 	<p>Communication lost (only available when the battery type is setting as any type of lithium-ion battery.)</p> <ul style="list-style-type: none"> • After battery is connected, communication signal is not detected for 3 minutes, buzzer will beep. After 10 minutes, inverter will stop charging and discharging to lithium battery. • Communication lost occurs after the inverter and battery is connected successfully, buzzer beeps immediately. 	
62 	Battery number is changed. It probably is because of communication lost between battery packs.	<p>Press "UP" or "DOWN" key to switch LCD display until below screen shows. It will have battery number re-checked and 62 warning code will be clear.</p> 
69 	If battery status is not allowed to charge after the communication between the inverter and battery is successful, it will show code 69 to stop charging battery.	
70 	If battery status must to be charged after the communication between the inverter and battery is successful, it will show code 70 to charge battery.	
71 	If battery status is not allowed to discharge after the communication between the inverter and battery is successful, it will show code 71 to stop discharging battery.	

Appendix III: The Wi-Fi Operation Guide in Remote Panel

1. Introduction

Wi-Fi module can enable wireless communication between off-grid inverters and monitoring platform. Users have complete and remote monitoring and controlling experience for inverters when combining Wi-Fi module with WatchPower APP, available for both iOS and Android based device. All data loggers and parameters are saved in iCloud.

The major functions of this APP:

- Delivers device status during normal operation.
- Allows to configure device setting after installation.
- Notifies users when a warning or alarm occurs.
- Allows users to query inverter history data.



2. WatchPower App

2-1. Download and install APP

Operating system requirement for your smart phone:

🍏 iOS system supports iOS 9.0 and above

🤖 Android system supports Android 5.0 and above

Please scan the following QR code with your smart phone and download WatchPower App.



Android system





iOS system

Or you may find "WatchPower" app from the Apple® Store or "WatchPower Wi-Fi" in Google® Play Store.



2-2. Initial Setup

Step 1: Registration at first time

After the installation, please tap the shortcut icon  to access this APP on your mobile screen. In the screen, tap "Register" to access "User Registration" page. Fill in all required information and scan the remote box PN by tapping  icon. Or you can simply enter PN directly. Then, tap "Register" button.



Then, a "Registration success" window will pop up. Tap "Go now" to continue setting local Wi-Fi network connection.

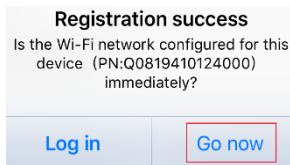

Step 2: Local Wi-Fi Module Configuration

Now, you are in "Wi-Fi Config" page. There are detailed setup procedure listed in "How to connect?" section and you may follow it to connect Wi-Fi.

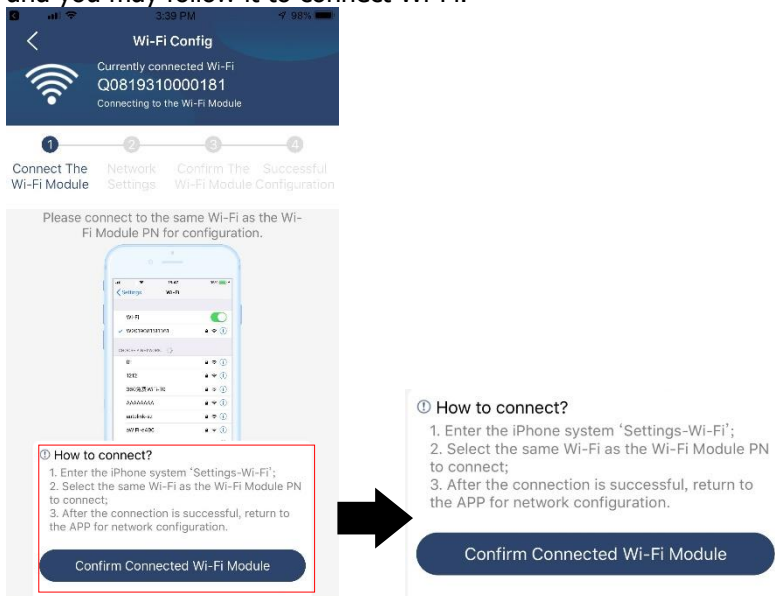

Enter the "Settings→Wi-Fi" and select connected Wi-Fi name. The connected Wi-Fi name is the same to your Wi-Fi PN number and enter default password "12345678".

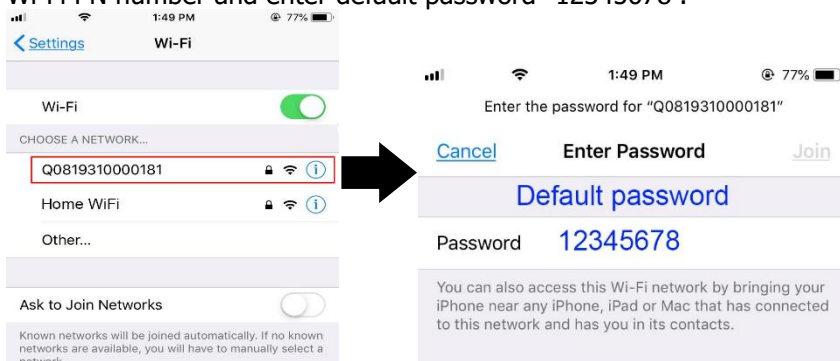

Then, return to WatchPower APP and tap "Confirm Connected Wi-Fi Module" button when Wi-Fi module is connected successfully.

Step 3: Wi-Fi Network settings

Tap  icon to select your local Wi-Fi router name (to access the internet) and enter password.

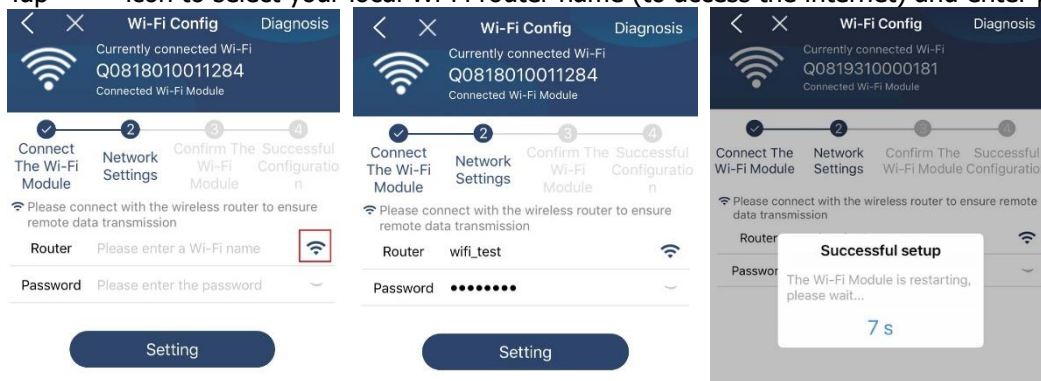

Step 4: Tap "Confirm" to complete the Wi-Fi configuration between the Wi-Fi module and the Internet.

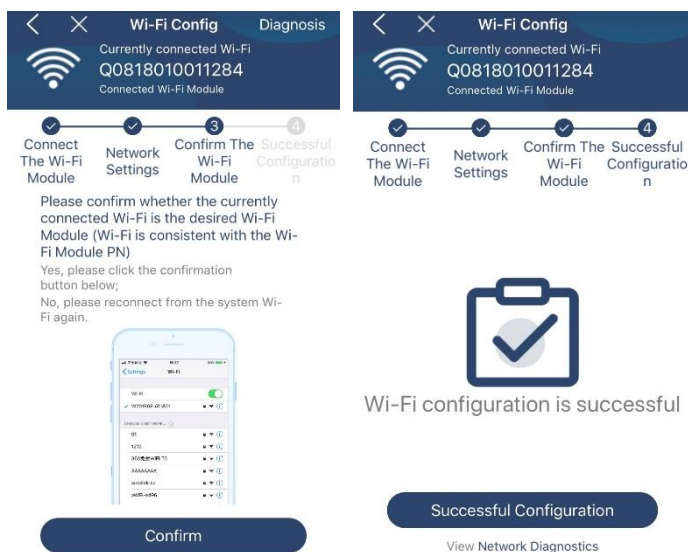

If the connection fails, please repeat Step 2 and 3.

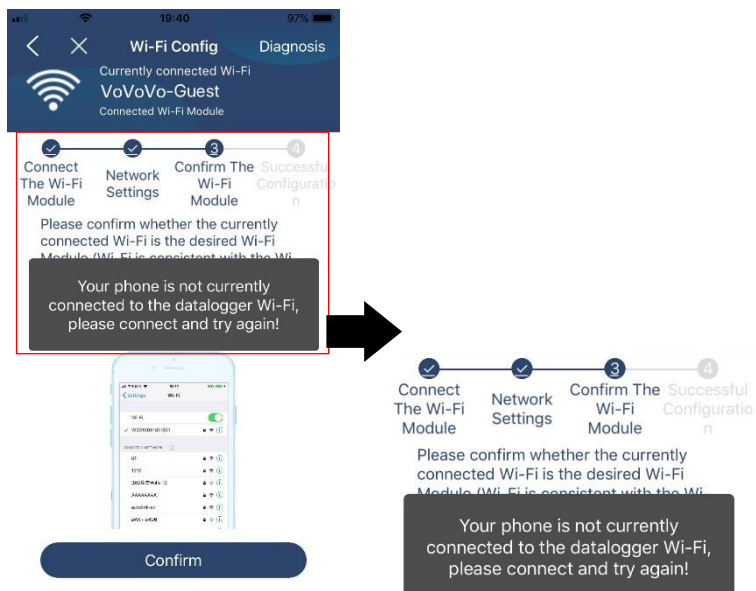

Diagnose Function

If the module is not monitoring properly, please tap "Diagnosis" on the top right corner of the screen for further details. It will show repair suggestion. Please follow it to fix the problem. Then, repeat the steps in the chapter 4.2 to re-set network setting. After all setting, tap "Rediagnosis" to re-connect again.

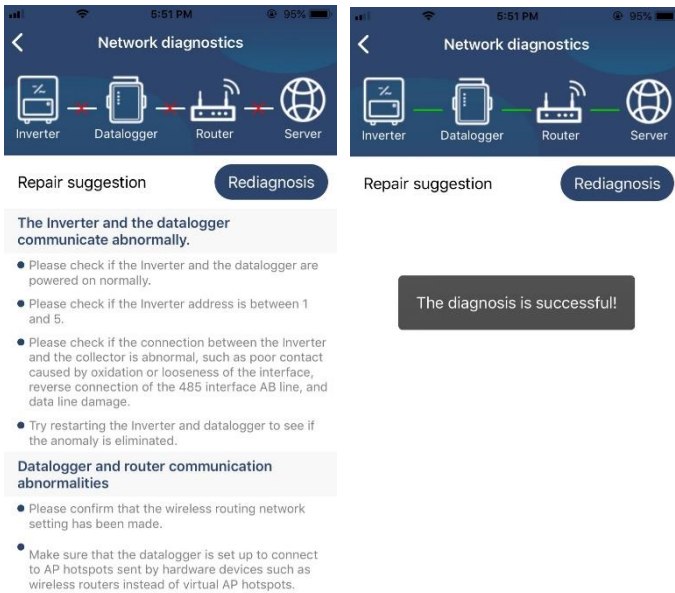

2-3. Login and APP Main Function

After finishing the registration and local Wi-Fi configuration, enter registered name and password to login.
 Note: Tick "Remember Me" for your login convenience afterwards.

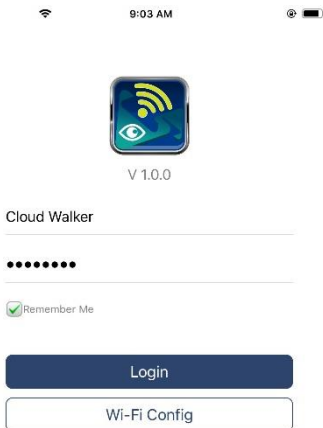

Overview

After login is successfully, you can access "Overview" page to have overview of your monitoring devices, including overall operation situation and Energy information for Current power and Today power as below diagram.

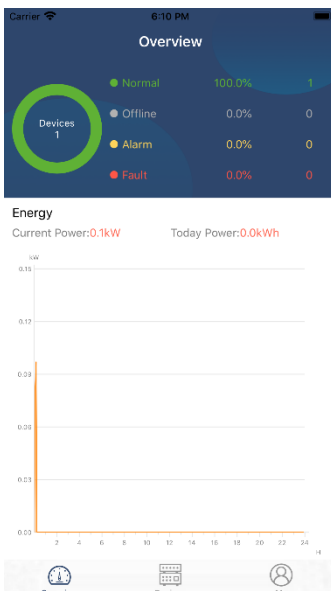

Devices

Tap the  icon (located on the bottom) to enter Device List page. You can review all devices here by adding or deleting Wi-Fi Module in this page.

Add device

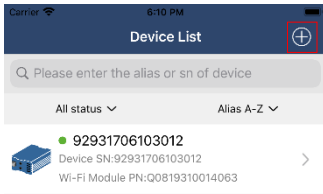

Delete device

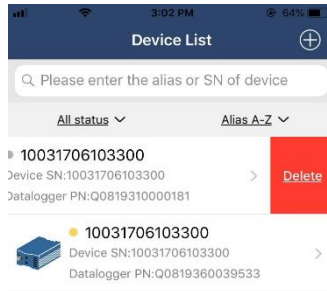

Tap  icon on the top right corner and manually enter part number to add device. This part number label is pasted on the bottom of remote LCD panel. After entering part number, tap "Confirm" to add this device in the Device list.

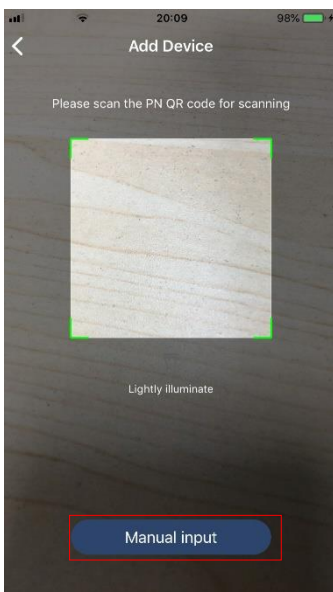

Part number label is pasted on the bottom of remote LCD panel.

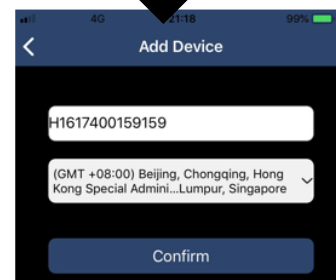
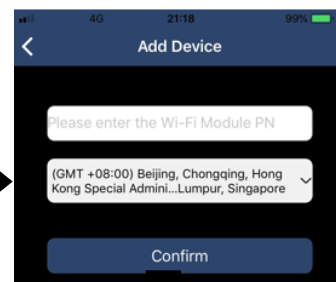

For more information about Device List, please refer to the section 2.4.

ME

In ME page, users can modify "My information", including **【User's Photo】**, **【Account security】**, **【Modify password】**, **【Clear cache】**, and **【Log-out】**, shown as below diagrams.

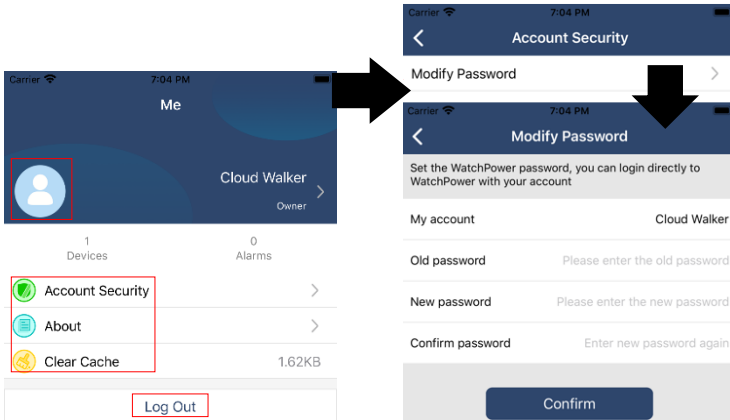

2-4. Device List

In Device List page, you can pull down to refresh the device information and then tap any device you want to check up for its real-time status and related information as well as to change parameter settings. Please refer to the parameter setting list.

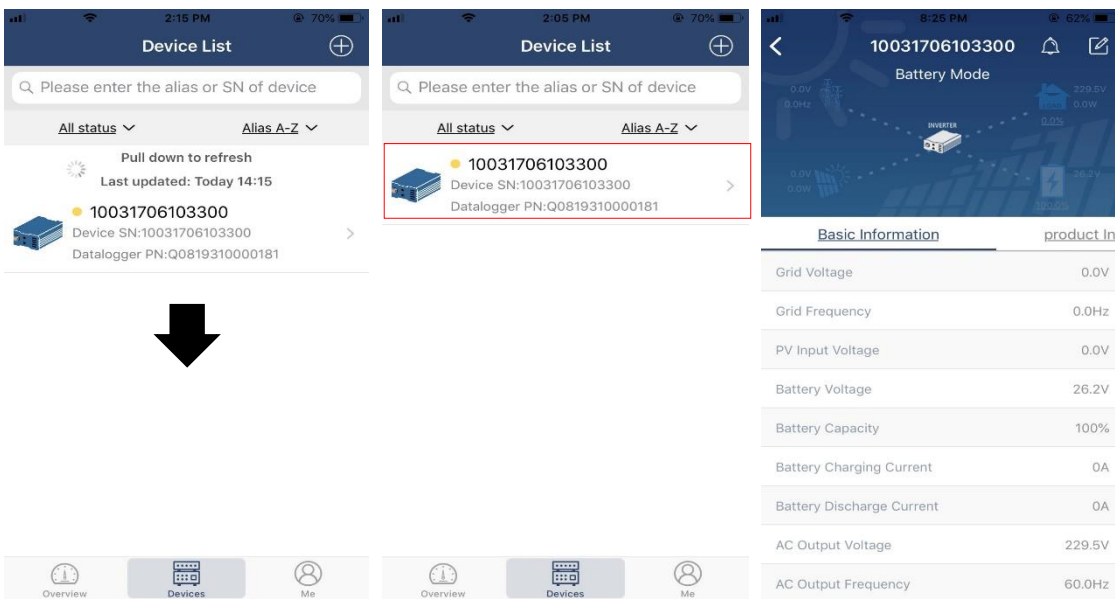

Device Mode

On the top of screen, there is a dynamic power flow chart to show live operation. It contains five icons to present PV power, inverter, load, utility and battery. Based on your inverter model status, there will be **【Standby Mode】**, **【Line Mode】**, **【Battery Mode】**.

【Standby Mode】 Inverter will not power the load until "ON" switch is pressed. Qualified utility or PV source can charge battery in standby mode.

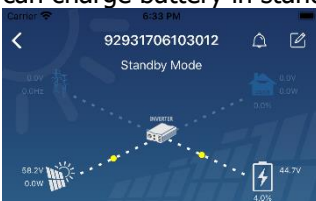

【Line Mode】 Inverter will power the load from the utility with or without PV charging. Qualified utility or PV source can charge battery.



【Battery Mode】 Inverter will power the load from the batter with or without PV charging. Only PV source can charge battery.



Device Alarm and Name Modification

In this page, tap the  icon on the top right corner to enter the device alarm page. Then, you can review alarm history and detailed information. Tap the  icon on the top right corner, a blank input box will pop out. Then, you can edit the name for your device and tap "Confirm" to complete name modification.

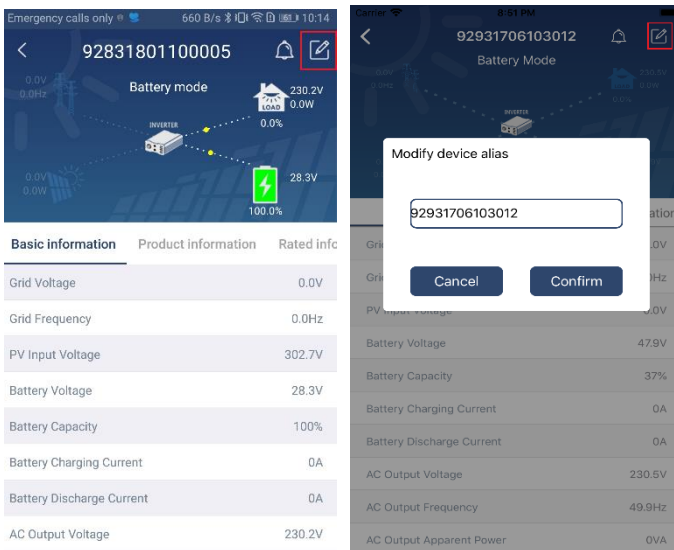

Device Information Data

Users can check up **【Basic Information】** , **【Product Information】** , **【Rated information】** , **【History】** , and **【Wi-Fi Module Information】** by swiping left.

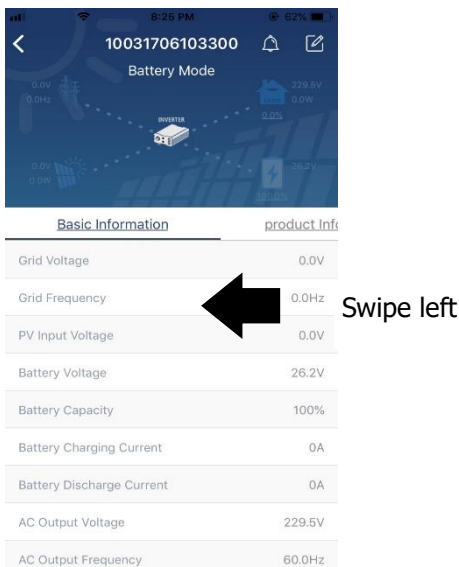

【Basic Information】 displays basic information of the inverter, including AC voltage, AC frequency, PV input voltage, Battery voltage, Battery capacity, Charging current, Output voltage, Output frequency, Output apparent power, Output active power and Load percent. Please slide up to see more basic information.

【Production Information】 displays Model type (Inverter type), Main CPU version, Bluetooth CPU version and secondary CPU version.

【Rated Information】 displays information of Nominal AC voltage, Nominal AC current, Rated battery voltage, Nominal output voltage, Nominal output frequency, Nominal output current, Nominal output apparent power and Nominal output active power. Please slide up to see more rated information.

【History】 displays the record of unit information and setting timely.

【Wi-Fi Module Information】 displays of Wi-Fi Module PN, status and firmware version.

Parameter Setting

This page is to activate some features and set up parameters for inverters. Please be noted that the listing in "Parameter Setting" page in below diagram may differ from the models of monitored inverter. Here will briefly highlight some of it, **【Output Setting】** , **【Battery Parameter Setting】** , **【Enable/ Disable items】** , **【Restore to the defaults】** to illustrate.

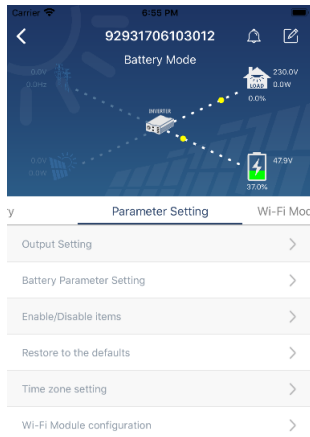

There are three ways to modify setting and they vary according to each parameter.

- a) Listing options to change values by tapping one of it.
- b) Activate/Shut down functions by clicking "Enable" or "Disable" button.
- c) Changing values by clicking arrows or entering the numbers directly in the column.

Each function setting is saved by clicking "Set" button.

Please refer to below parameter setting list for an overall description and be noted that the available parameters may vary depending on different models. Please always see the original product manual for detailed setting instructions.

Parameter setting list:

Item		Description
Output setting	Output source priority	To configure load power source priority.
	AC input range	When selecting "UPS", it's allowed to connect personal computer. Please check product manual for details.
		When selecting "Appliance", it's allowed to connect home appliances.
	Output voltage	To set output voltage.
Output frequency	To set output frequency.	
Battery parameter setting	Battery type:	To set connected battery type.
	Battery cut-off voltage/SOC	To set the battery stop discharging voltage or SOC. Please see product manual for the recommended voltage or SOC range based on connected battery type.
	Back to grid voltage/SOC	When "SBU" or "SOL" is set as output source priority and battery voltage is lower than this setting voltage or SOC, unit will transfer to line mode and the grid will provide power to load.
	Back to discharge	When "SBU" or "SOL" is set as output source priority and battery voltage is higher than this setting voltage or SOC, battery will be

	voltage/SOC	allowed to discharge.
	Charger source priority:	To configure charger source priority.
	Max. charging current	It's to set up battery charging parameters. The selectable values in different inverter model may vary. Please see product manual for the details.
	Max. AC charging current:	
	Float charging voltage	
	Bulk charging voltage	It's to set up battery charging parameters. The selectable values in different inverter model may vary. Please see product manual for the details.
	Battery equalization	Enable or disable battery equalization function.
	Real-time Activate Battery Equalization	It's real-time action to activate battery equalization.
	Equalized Time Out	To set up the duration time for battery equalization.
	Equalized Time	To set up the extended time to continue battery equalization.
	Equalization Period	To set up the frequency for battery equalization.
	Equalization Voltage	To set up the battery equalization voltage.
Enable/Disable Functions	LCD Auto-return to Main screen	If enable, LCD screen will return to its main screen after one minute automatically.
	Fault Code Record	If enabled, fault code will be recorded in the inverter when any fault happens.
	Backlight	If disabled, LCD backlight will be off when panel button is not operated for 1 minute.
	Bypass Function	If enabled, unit will transfer to line mode when overload happened in battery mode.
	Beeps while primary source interrupt	If enabled, buzzer will alarm when primary source is abnormal.
	Over Temperature Auto Restart	If disabled, the unit won't be restarted after over-temperature fault is solved.
	Overload Auto Restart	If disabled, the unit won't be restarted after overload occurs.
	Buzzer	If disabled, buzzer won't be on when alarm/fault occurred.
L2 output (second output) setting	Battery Cut off Voltage/SOC L2	To set the battery stop discharging voltage or SOC on L2 output.
	Discharge Time L2	To set the battery stop discharging time on L2output.
	Time Interval to Turn on L2	To set time interval to turn on L2 output.
RGB LED Setting	Enable/disable	Turn on or off RGB LEDs
	Brightness	Adjust the lighting brightness

	Speed	Adjust the lighting speed
	Effects	Change the light effects
	Color selection	Adjust color combination to show energy source an battery status
Restore to the default	This function is to restore all settings back to default settings.	